

LP Gas & Anhydrous Ammonia Equipment Manufacturer

2014



Innovation Made Simple

Innovation Made Simple

For over 35 years Marshall Excelsior Company has been a progressive manufacturer of top quality and competitively priced LPG & NH₃ equipment that is leading the industry in innovation and low emission products. We offer a full range of products that support the LPG & NH₃ Bulk Plant, Transport, Delivery/Dispensing, and Domestic applications. As our product line continues to grow, we are striving to improve product functionality while taking the industry standards to a higher level of quality and performance without adding excessive cost. While following along this path, our engineering staff exercises a heavy reliance on the input from our customers throughout any new product design phase. It has been through these theories and approaches that we have been able to carve out our niche in an industry where safety and performance must work hand-in-hand. Our goal is to create the safest equipment solutions for everyday operations while allowing the largest amount of product to be transferred, dispensed, or otherwise used, resulting in an overall savings to the customer.

In addition to our company philosophy for new product development, you will find our approach to daily operations equally unique. In a time where materials, fuels, and other manufacturing costs are on the rise, we have not only remained competitive, but one of the industry leaders in on-time deliveries and short lead-times. The reason is simple; we not only manufacture our products effectively, but carry one of the most extensive on-hand inventories available in the industry. This allows our distributors to react quickly without having an excessive amount of stock on hand.

Put this together with our proactive, responsive sales and customer service staff and you have a winning combination.

As one of the industry leaders in responsiveness it is essential for our organization to be able to react in a rapid fashion, hence our fully integrated manufacturing and purchasing process. Our capabilities in manufacturing range from high volume to custom made product. Both of which are supported by our wide variety of manufacturing equipment, highly skilled personnel, and dedicated purchasing staff. Combine these attributes with our top notch ISO9001 quality system and you have a combination that easily rivals that of our nearest competition.

Over the course of time Marshall Excelsior Company has become a name that our customers can rely on not only for high quality products and services, but as a partner in building their business. Together, with our commitment to the industries served and our eagerness to improve and expand our product-line our customers routinely find the opportunity to promote our organization. It is through this personal touch that our family owned and operated business has become the organization that it is today. We are confident that as our company continues to develop and mature in our industries, Marshall Excelsior Company will become a brand of choice.



ISO
Registered Firm
9001



Marshall Excelsior Company
1506 George Brown Drive, Marshall, MI 49068
269-789-6700 Fax: 269-781-8340
E-mail: sales@marshallexcelsior.com
www.marshallexcelsior.com



About This Catalog

This catalog is designed to provide a comprehensive overview of Marshall Excelsior's products. Due to the continuous development and additions to our product lines, this catalog may not include all products Marshall Excelsior offers. To see any new products that have been developed after this publication visit www.marshallexcelsior.com.

Pictures in this catalog will resemble the product shown. However, due to continuous improvements and changes in regulations, we do not guarantee that the picture in this catalog will be the exact replica of the product purchased. Any pictures shown in a group of products will resemble the other products being offered in the same group unless otherwise stated.

Marshall Excelsior is a manufacturer of LP-Gas and anhydrous ammonia (NH₃) equipment. Unless otherwise stated, all products are designed and manufactured to be used only with LP-Gas or NH₃ and can withstand temperatures from -40° to +165° Fahrenheit. If there is a product that you would like to use for a different application contact your authorized Marshall Excelsior Distributor or Marshall Excelsior before installing the product.

This catalog is for general information only and should not be viewed as an all inclusive catalog of important technical information, regulations, warnings or installation instructions. Contact your authorized Marshall Excelsior Distributor or Marshall Excelsior for more information.

Compliance

Marshall Excelsior manufactures all of our products to the highest industry standards. All of our products meet or exceed the requirements of the Compressed Gas Association (CGA), the National Fire Protection Association (NFPA), American National Standards Institute (ANSI), American Society of Mechanical Engineers (ASME) or Underwriters Laboratories, Inc. (UL) where indicated.

Product Changes

Marshall Excelsior reserves the right to change product specifications at any time. We are constantly evaluating our products and incorporating engineering advances to ensure our products perform and comply with changes in market conditions, government mandates, and code changes. Marshall Excelsior shall not be required to modify any equipment already sold or in service.

Filters

Marshall Excelsior develops products to be used in a debris, dirt and contamination free system. Installing an in-line filter may be necessary in a system that contains unclean product or when the system contains debris, dirt, scale, rust or other contaminants.

Product Age

Marshall Excelsior products are mechanical devices that are subject to wear, contaminants, corrosion, and aging of components made of materials such as rubber and metal. Over time these devices will eventually become inoperative. The safe service life of these products will reflect the environment and conditions of use that they are subjected to. **Regular inspection and maintenance is essential.** Marshall Excelsior products have a long record of quality and service, so LP-Gas dealers may forget hazards that can arise from using aging devices that have outlived their safe service life. The length of a device's life is determined by the environment in which it is used, and the LP-Gas dealer knows better than anyone about this environment.

There are developing trends in state legislation and proposed national legislation making the owner of products responsible for replacing products before they outlive their safe service life. LP-Gas dealers should be aware of such legislation as it affects them.

To determine the product's age, check the product for a date code consisting of a series of letters and numbers.

A = January	B = February	C = March
D = April	E = May	F = June
G = July	H = August	I = September
J = October	K = November	L = December

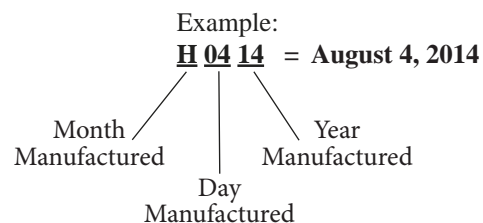



New Products



TURBO-FLO LE
Shut Off Valves

ME807-16
Pg. 26



Full Port
Flanged
Globe Valves

ME825-3F
Pg. 33

Excelerator™
High Flow
Railcar ESV's



ME983 Series
Pg. 68

Flanged
Y-Strainers



ME656S-3F
Pg. 80

Excelerator™
Internal Valves
1-1/4" Threaded
Tee Body



ME992-10
Pg. 55

2014

Second Stage Regulators

Compact, Full Size and
Back Mount



MEGR-1222-BAF
Pg. 9

Automatic Changeover Regulators



MEGR-253
Pg. 13

Pilot Operated/ Industrial Regulators



MEGR-199 Series
Pg. 24

EXCELA-FLO Regulators

Automatic Changeover Regulators



Compact
and Full Size

MEGR-175CS61222-BAF
Pg. 12

Integral Two-Stage Regulators



Compact
and Full Size

MEGR-1632 Series
Pg. 10

First Stage Regulators

Compact
and Full Size



MEGR-1122H Series
Pg. 8

2 PSI Service Regulators

Compact and Full Size



MEGR-1652E Series
Pg. 11

Excela-Flo Domestic Regulators

Features and Benefits

1. Dust cap with hex and finger grips
 2. Full round flange for evenly distributed compression
 3. Locating tabs
 4. Premium powder coat inside and out
 5. Large wrench flats
 6. Ribbed vent screen for easy removal
 7. Fabric reinforced molded diaphragm
 - a. Interlocking diaphragm and diaphragm plate.
 - b. Rounded edges on diaphragm plate
 - c. Sealing and locating bead on diaphragm
 8. Travel stops - to prevent damage to diaphragm
 9. Stainless steel lever design
 10. Pre-installed mounting screws for installation convenience
 11. Large aluminum orifice
 12. Large drip vent
 13. Adjustment direction indicator
 14. Plugged high pressure gauge port on all integral two stage regulators
 15. Tear off data label for installation records
 16. (FKM) Fluorocarbon seats for maximum protection against contamination
- * Some features - Patent Pending

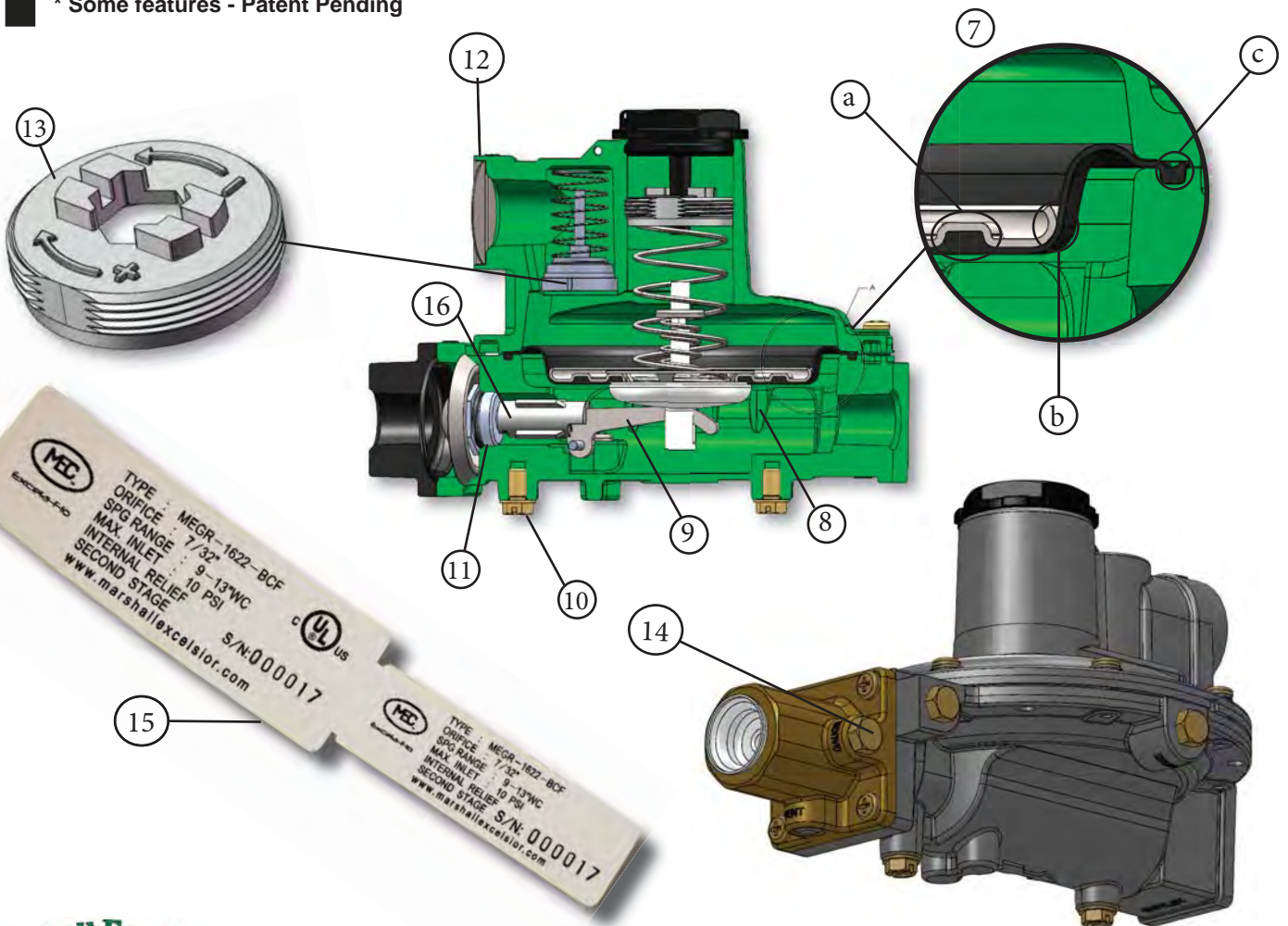
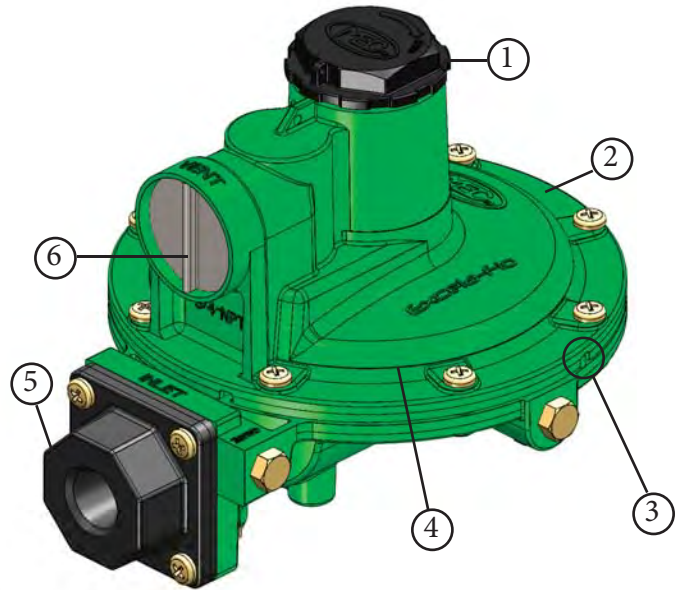

Excelsa-Flo Domestic Regulators

Installation and Operating Instructions For: 1100, 1200 and 1600 Excelsa-Flo Series Regulators

!WARNING!

Failure to follow these instructions or to properly install and maintain this equipment could result in an explosion and/or fire causing property damage and personal injury or death.

Marshall Excelsior equipment must be installed, operated and maintained in accordance with federal, state and local codes and MEC instructions. The installation in most states must also comply with NFPA 54 and NFPA 58 standards.

Only personnel trained in the proper procedures, codes, standards and regulations of the LP-Gas industry shall install and service this equipment.

Things to tell the gas customer:

1. Show the customer the vent, vent assembly or vent line. Stress that this opening must remain unobstructed at all times. Tell the customer to check the vent opening after a freezing rain, sleet storm, or snow to make sure ice has not formed in the vent.
2. Show the customer the shutoff valve on the container. The customer should close this valve immediately if gas is smelled, appliance pilot lights fail to stay on or appear higher than usual or any other abnormal situation occurs.
3. Tell the customer to call your company to service the regulator if the regulator vents gas or a leak develops in the system. **Only a qualified gas service person shall install or service the regulators.**

Scope of the Manual

This instruction manual covers installation and maintenance for the first stage, second stage, and integral two-stage regulators used on LP-Gas vapor service applications. **They are not to be used on liquid service.**

Description

25 Year Recommended Replacement Life: The MEC Regulator Series is designed using rugged time-proven design concepts and constructed of corrosion resistant materials, both internally and externally. With proper installation and periodic inspection and maintenance, they will meet a 25 Year Recommended Replacement Life.

Screened Drip-Lip: Screened Drip-Lip is oriented either over the inlet, outlet, or at 90° depending on the configuration.

Pressure Tap Size Restrictions: 1/8" NPT / #54 (0.055") orifice on all pressure points.

Temperature Capabilities: -40°F to 160°F (-40°C to 71°C)

Contact the factory if the regulator is to be used on any service other than LP-Gas. The following information is located on the spring case: The Part Number, orifice size, spring range and date code.

2nd Stage Low Pressure Regulator - UL Listed:

The second stage regulator is designed to reduce the outlet pressure from a first-stage regulator (usually 10 psig (0,69bar)) to an outlet pressure of 11 -inches water column (27 bar).

The combination of a high capacity relief valve and large vent provide overpressure protection which exceeds UL standards and is capable of limiting the downstream pressure to 2 psig (0,14 bar) even in a double failure situation when used with a first-stage regulator.

Integral Two-Stage Regulator - UL Listed:

The integral two-stage regulator contains a non-adjustable first stage regulator on the inlet of the second stage portion of the regulator. It is designed to reduce the tank pressure to an outlet pressure of 11 inches



Figure 1: 1200 Series and 1600 Series Regulators

water column. The second stage portion has a high capacity internal relief valve construction. The first stage does not have an internal relief valve.

First Stage Regulator - UL Listed:

The first stage regulators are designed for high pressure (pounds per square inch) vapor service. These regulators have high capacity internal relief valves. The outlet pressure setting is factory set at a nominal 10 psig.

Installation

!WARNING!

All vents should be kept open to permit free flow of air in and out of the regulator. Protect vent openings against the entrance of rain, snow, ice formation, paint, mud, insects or any other foreign material that could plug the vent or vent line.

LP-Gas may discharge to the atmosphere through the vent. An obstructed vent which limits air or gas flow can cause abnormally high pressure that could result in personal injury or property damage.

The first stage and integral two-stage regulators are not suitable for indoor installations. Never use them on low pressure (inches of water column) service because personal injury or property damage could occur.

Before installation:

- Check for damage, which may have occurred in shipment.
- Check for and remove any dirt or foreign material that may have accumulated in the regulator body.
- Replace old pigtails. Blow out any debris, dirt or copper sulfate in the copper tubing and the pipeline.
- Apply pipe compound to the male threads of the pipe before installing the regulator.
- Make sure gas flow through the regulator is in the same direction as the arrow on the body. "Inlet" and "Outlet" connections are clearly marked.

Installation Location, see Figure 2:

- The installed regulator should be adequately protected from vehicular traffic and damage from other external sources.
- **Install the regulator with the vent pointed vertically down.** If the vent cannot be installed in a vertically down position, the regulator must be installed under a separate protective cover. Installing the regulator with the vent down allows condensation to drain,

Excela-Flo Domestic Regulators

minimizes the entry of water or other debris from entering the vent, and minimizes vent blockage from freezing precipitation.

- **Do not install the regulator in a location where there can be excessive water accumulation or ice formation**, such as directly beneath a down spout, gutter or roof line of building. Even a protective hood may not provide adequate protection in these instances.
- Install the regulator so that any gas discharge through the vent or vent assembly is over 3 -feet (0,9 meters) horizontally from any building opening below the level of discharge and not less than 5-feet in any direction away from any source of ignition, openings into direct vent appliances, or mechanical ventilation air intakes.
- Install the regulator high enough above ground level - at least 24-inches (60 cm) - so that rain splatter cannot freeze in the vent.
- Some installations, such as in areas with heavy snowfall, may require a hood or enclosure to protect the regulator from snow load and vent freeze over.

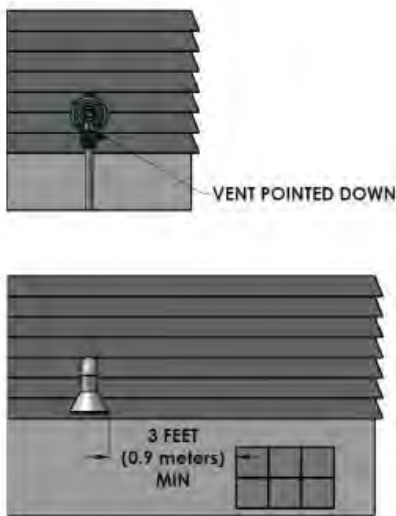

Figure 2: Regulator with Vent Pointed Down

Horizontally Installed Regulators, see Figure 3:

Horizontally mounted regulators, such as found in single cylinder installations and ASME tanks, must be installed beneath a protective cover or under the ASME tank dome. If possible, slope or turn the vent down sufficiently to allow any condensation to drain out of the spring case. Be careful that the slot in the tank dome or protective cover for the regulator's outlet piping does not expose the vent to the elements. The first stage vent on the integral two-stage regulator should be pointed down.

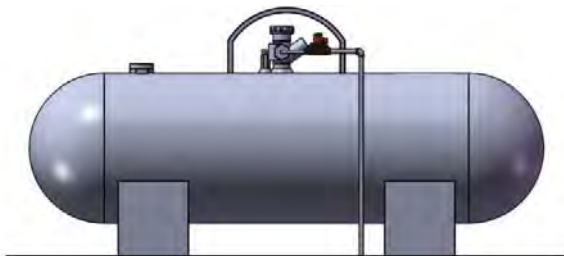

Figure 3: Tank Installation

Indoor Installations, see Figure 4:

The first stage and integral regulators are not recommended for indoor installations. The second stage regulator may be installed indoors as follows.

By code, regulators installed indoors have limited inlet pressure, and they require a vent line to the outside of the building. A vent assembly, such as MEC ME960 or at least 3/4" NPT pipe, Gray PVC Schedule 40 Rigid Non-Metallic Electrical Conduit for above Ground Service, per UL 651, should be used. The same installation precautions, previously discussed throughout this manual for the regulator vent, apply to the end of the vent tube assembly. Vent lines must not restrict the gas flow from the regulator's internal relief valve. To install the vent line, remove the vent screen and apply a good grade of pipe compound to the male threads of the line. Vent lines should be as straight as possible with a minimum number of bends.

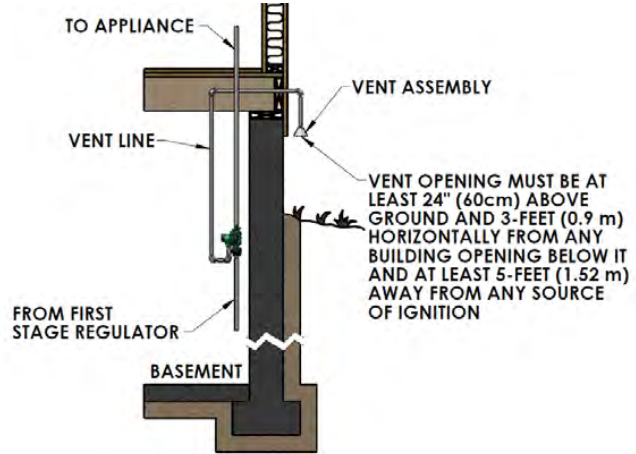

Figure 4: Basement Installation

Underground Installations, see Figure 5:

!WARNING!

The integral two-stage regulators require 2 vent lines, one for the first stage vent (1/4" OD copper tube inverted flare connection: 7/16-24 UN thread) and the other for the second stage vent (3/8" NPT) of the regulator. Failure to use 2 separate vent tubes can result in early regulator failure and / or over pressuring the second stage that could result in fire or personal injury.

A regulator installed in the dome of an underground container requires a vent line to prevent water from entering the regulator spring case.

Remove the vent screen(s) and install a vent line(s). The vent line must be run from the regulator vent(s) to above the maximum water table. The vent line opening(s) must terminate at the extreme top inside of the dome cover. Make sure the regulator's closing cap is on tightly, and maintain drainage away from the dome at all times.



Figure 5: Underground Installation

Excela-Flo Domestic Regulators

Adjustment

Each regulator is factory set. If it becomes necessary to increase the outlet pressure, remove the closing cap and turn the adjustment screw clockwise. Turn the adjusting screw counterclockwise to decrease the outlet pressure.

The inlet and outlet pressure tap plugs may be removed using a 7/16" wrench. The pressure tap is restricted with a #54 orifice, so the plug can be removed with pressure in the regulator. Install a pressure gauge to determine the regulator's inlet pressure and outlet setting during adjustment. Actual pressure at the second stage regulator may be less due to line loss. After setting, add thread sealant to the pipe plug and reinstall it. Replace the closing cap. Check the plug for leakage.

Overpressure Protection

!WARNING!

Some type of overpressure protection is needed if actual inlet pressure can exceed the inlet pressure rating. Overpressuring any portion of this equipment above the limits shown in the Specifications may cause damage to regulator parts, leaks in the regulator, or personal injury due to bursting of pressure-containing parts or explosion of accumulated gas.

If any portion of the regulator is exposed to an overpressure condition that exceeds the limits in the Specifications, it must be inspected for damage that may have occurred.

Large volumes of gas may discharge though the regulator vent during internal relief valve operation, which can, if not controlled, result in fire or explosion from accumulated gas.

The first stage, integral two-stage, and second stage series regulator, **except for the first stage of the integral two-stage**, contain internal relief valves. The internal relief valve in all units will give overpressure protection against excessive build-up resulting from seat leakage due to worn parts, chips or foreign material on the orifice. The amount of internal relief protection provided varies with the regulator type and the cause for the overpressure relief valve operation. When the internal relief valve opens, gas escapes to the atmosphere through the regulator's vent.

Some type of additional external overpressure protection must be provided if the outlet pressure in an overpressure condition exceeds the inlet pressure rating of the gas system or downstream equipment. Common methods of external overpressure protection include relief valves, monitoring regulators, shutoff devices, and series regulation.

Maintenance

!WARNING!

To avoid personal injury or equipment damage, do not attempt any maintenance or disassembly without first isolating the regulator from system pressure and relieving all internal pressure.

Regulators that have been disassembled for repair must be tested for proper operation before being returned to service. Only parts manufactured by MEC should be used for repairing MEC regulators. Relight pilot lights according to normal startup procedures found in the appliance manufacturers instructions.

Due to normal wear or damage that may occur from external sources, these regulators must be inspected and maintained periodically. The frequency of inspection and replacement of the regulators depends upon the severity of service conditions or the requirements of local, state and federal regulations. Even under ideal conditions, these regulators should be replaced after 25 years from date of manufacture or sooner should inspection reveal the need.

Visually inspect the regulator each time a gas delivery is made for:

- Improper installation; such as vent not pointed vertically down or under a cover, no vent line on underground systems
- Plugged or frozen vent
- Wrong regulator or no regulator in the system
- External corrosion
- Flooded Regulator; water in spring case, regulator submersed on underground tanks
- Regulator age
- Any other condition that could cause the uncontrolled escape of gas

Failure to do the above could result in personal injury or property damage.

Vent Opening

Make sure the regulator vent, vent assembly, or vent line does not become plugged by mud, insects, ice, snow, paint, etc. The vent screen aids in keeping the vent from becoming plugged; the screen should be clean and properly installed.

Water inside Regulators from Floods, Weather or Water Table on Underground Systems

Replace any regulator that has been flooded or has been submersed below the water, has water in the spring case or shows evidence of external or internal corrosion. Checking for internal corrosion on the first stage and integral two-stage of the second stage portion, can be done by removing the closing cap and with the aid of a flashlight observing the condition of the relief valve spring, main spring and internal spring barrel area. A more detailed examination will require shutting down the gas system and the complete removal of the adjusting screw. The second stage regulator must be completely disassembled by a qualified person to look for internal corrosion. Closely examine regulators installed with their vent horizontal for signs of corrosion. Correct any improper installations.

Regulator Replacement

Older regulators are more likely to fail catastrophically because of worn or corroded parts. Replace all regulators over 25 years of age. Other service or environmental conditions may dictate replacement of the regulator before the end of its 25 year service life.

Regulators that are installed on underground systems and in areas that are subject to sea salt (coastal) atmospheres should be inspected annually for external and internal corrosion and may require replacement sooner.

Regulator Repair

Only personnel trained in the proper procedures, codes, standards and regulations of the LP-Gas industry shall install and service this equipment.

Regulators that have been disassembled for repair must be tested for proper operation before being returned to service. Only parts manufactured by MEC should be used to repair MEC regulators. Be sure to give the complete Part Number of the regulator when corresponding with the factory.

The part number, orifice size, and spring range are on a label attached to the spring barrel. The date of manufacture is stamped on the regulator. Always provide this information in any correspondence with your MEC Distributor regarding replacement parts or technical assistance. **If construction changes are made in the field, be sure that the regulator marking is also changed to reflect the most recent construction.**

Excela-Flo First Stage Domestic Regulators

These first stage regulators are used to reduce LP gas tank pressures for a second stage regulator (normally 10 PSIG). All MEC first stage regulators are red indicating high outlet pressure. First stage full size regulator vents have 3/4" FNPT tapped ports and E-Z Grip screens located over the outlet. Both the MEGR-1122H and the MEGR-1622H series offer optimal relief performance that exceeds UL test requirements providing double failure overpressure protection when used with MEC MEGR-1622 & MEGR-1652 series second stage regulators. All MEC Excela-Flo domestic regulators feature a 25 year recommended replacement life and the MEC exclusive tear away leak check adhesive sticker.



MEGR-1122H Series: Offers a compact first stage regulator design perfect for tight applications such as underground tank domes. They feature an adjustment range from 9-12 PSIG (factory set @ 10 PSIG), stainless steel internal components, fluorocarbon (FKM) seat discs, molded lip fabric reinforced diaphragms and large aluminum precision machined orifice to minimize freeze ups while providing superior downstream regulation and maximum corrosion resistance against weather or contaminated gas. Compact series regulators feature 3/8" FNPT drip lip vent openings.



Regulator Specifications

- Type: First Stage
- Max. Inlet Pressure: 250 PSIG
- Exterior Finish: Red Powder Coat
- Orifice Size: .150" (Compact) & .219" Full
- Diaphragm: Fabric Reinforced NBR Molded Lip O-Ring Bonnet/Body Seal
- Relief Type: Internal Relief - Spring Loaded
- Bonnet / Body Material: Die Cast Aluminum
- Seat Material: Fluorocarbon (FKM)
- Listings: cUL_{US} / UL 144
- Mounting Holes: Standard 3-1/2" Center
- Pressure Taps: #54 Orifice, 1/8" FNPT, Plugged (2)
- Relief Travel Stop: Molded in Adjustment Cap - Gray (Compact), Black (Full Size)

MEGR-1622H Series: Offers all of the same features as the compact MEGR-1122H Series in a full size version. Our full size MEGR-1622H Series has a large fabric reinforced diaphragm for superior downstream regulation, heavy duty wrench flats, and a large 3/4" FNPT tapped drip lip vent to help prevent relief vent blockage.



Part No.	Type	Capacity in BTU/H LPG ⁽¹⁾	Inlet	Outlet	Vent Port	Outlet Adj. Range (PSI)	Outlet Set Point (PSI)
MEGR-1122H-AAJ	Compact	1,000,000	1/4" FNPT	1/2" FNPT	3/8" FNPT	8-12	10
MEGR-1122H-AAJXB ⁽²⁾	Compact	1,000,000	1/4" FNPT	1/2" FNPT	3/8" FNPT	8-12	10
MEGR-1622H-BGJ	Full Size	2,200,000	1/2" FNPT	1/2" FNPT	3/4" FNPT	8-12	10
MEGR-1622H-DGJ	Full Size	2,500,000	3/4" FNPT	3/4" FNPT	3/4" FNPT	8-12	10
MEGR-1622H-HGJ	Full Size	2,300,000	F. POL	1/2" FNPT	3/4" FNPT	8-12	10
MEGR-1622H-JGJ	Full Size	2,750,000	F. POL	3/4" FNPT	3/4" FNPT	8-12	10

(1) Based on 30 PSIG Inlet pressure and 20% droop
 (2) Indicates vent orientation over pressure taps

Excela-Flo Second Stage Domestic Regulators

These second stage regulators are used to reduce outlet pressures from first stage regulators (normally 10 PSI) to 11" WC in domestic installations. All MEC second stage regulators are green indicating low outlet pressure. Second stage full size regulator vents have 3/4" FNPT tapped ports and our exclusive E-Z grip screens located over the inlet. All MEC second stage domestic regulators feature a stainless steel inlet filter screen to reduce debris from passing through the regulator. Both the MEGR-1622 and the MEGR-1652 Series offer optimal relief performance that exceeds UL test requirements providing double failure overpressure protection (no more than 2 PSI downstream pressure) when used with MEGR-1122H and MEGR-1622H Series First Stage regulators. All MEC Excela-Flo domestic regulators feature a 25 year recommended replacement life and our exclusive tear away leak check adhesive sticker.

Regulator Specifications

- Type: Second Stage
- Max. Inlet Pressure: 10 PSIG
- Exterior Finish: Green Powder Coat
- Orifice Size: .140" (Compact) & .219" (Full)
- Diaphragm: Fabric Reinforced (NBR) Molded Lip O-Ring Bonnet Body Seal
- Relief Type: Internal Relief - Spring Loaded
- Bonnet / Body Material: Die Cast Aluminum
- Seat Material: Fluorocarbon (FKM)
- Listings: cUL_{us} / UL 144
- Mounting Holes: Standard 3-1/2" Center
- Pressure Taps: #54 Orifice 1/8" FNPT Plugged (2)
- Relief Travel Stop: Molded In Adjustment Cap -
Black (Full Size), Gray (Compact)



MEGR-1222
Compact Series



MEGR-1222 Series: Offers a compact second stage regulator design perfect for lower BTU applications. They feature an adjustable range from 8-14" WC (factory set @ 11" WC), stainless steel internal components, fluorocarbon (FKM) seat discs, molded lip fabric reinforced diaphragms and large aluminum precision machined orifices providing superior downstream regulation and maximum corrosion resistance against weather or contaminated gas. Compact series regulators feature 3/8" FNPT drip lip vent openings.

MEGR-1622
Full Size Series



MEGR-1652
Back Mount Series



MEGR-1622 & MEGR-1652 Series:

Offers all of the same features as the compact MEGR-1122 Series but in a full size, high capacity version. Our full size second stage regulators have a large fabric reinforced diaphragm for superior downstream regulation, heavy duty wrench flats, and a large 3/4" FNPT tapped drip lip vent to help prevent relief valve blockage. The MEGR-1622 Series have both the inlet and outlet in line where the MEGR-1652 series have a rear discharge back mount outlet for convenient wall mount applications.

Part No.	Type	Capacity in BTU/H LPG ⁽¹⁾	Inlet	Outlet	Vent Port	Outlet Adj. Range ("WC)	Outlet Set Point ("WC)
MEGR-1222-BAF	Compact	500,000	1/2" FNPT	1/2" FNPT	3/8" FNPT	9.5-13	11
MEGR-1622-BCF	Full Size	710,000	1/2" FNPT	1/2" FNPT	3/4" FNPT	9-13	11
MEGR-1622-CFF	Full Size	1,300,000	1/2" FNPT	3/4" FNPT	3/4" FNPT	9-13	11
MEGR-1622-DFE	Full Size	1,300,000	3/4" FNPT	3/4" FNPT	3/4" FNPT	9-13	11
MEGR-1652-CFF ⁽²⁾	Back Mount	1,000,000	1/2" FNPT	3/4" FNPT	3/4" FNPT	9-13	11
MEGR-1652-DFE ⁽²⁾	Back Mount	1,000,000	3/4" FNPT	3/4" FNPT	3/4" FNPT	9-13	11

(1) Based on 10 PSIG inlet pressure and 20% droop
(2) Indicates back mount configuration

Excelsa-Flo Integral Two-Stage Domestic Regulators

These integral two-stage regulators combine the first and second stage regulator set-up into one convenient unit converting full tank pressure to 11" WC. All MEC integral two-stage domestic regulators are gray indicating low outlet pressure. Integral two-stage regulators are recommended for installations with short piping distances, but provide the same advantages of two-stage regulation with a single unit. All MEC integral two-stage regulator vent have tapped ports (7/16"-24-First Stage) (3/8" FNPT Second Stage Compact / 3/4" FNPT Second Stage Full Size) and our exclusive E-Z Grip screens located over the outlet. Both the MEGR-1232 and MEGR-1632 series offer optimal relief performance that exceeds UL test requirements providing over pressure protection of no more than 2 PSI downstream pressure. MEC Excelsa-Flo integral two-stage domestic regulators feature a 25 year recommended replacement life, our exclusive Tri-Tap™ (Tank, 10 PSI, 11" WC) pressure port system and tear away leak check adhesive sticker.



MEGR-1232 Compact Series: Offers a compact integral two-stage regulator design perfect for lower BTU applications and confined spaces. They feature an adjustment range from 8-14" WC (factory set @ 11" WC). Stainless steel integral components, fluorocarbon (FKM) seat discs, molded lip fabric reinforced diaphragms, and large precision machined aluminum orifices providing superior downstream regulation and maximum corrosion resistance against weather or contaminated gas. Compact series regulators feature 3/8" FNPT drip lip vent openings.



MEGR-1632 Full Size Series: Offers all of the same features as the compact MEGR-1232 series in a full size high capacity version. The full size MEGR-1632 diaphragm provides superior downstream regulation, has heavy duty wrench flats and a large 3/4" FNPT tapped drip lip vent to help prevent relief vent blockage.

Regulator Specifications

- Type: Integral Two-Stage
- Max. Inlet Pressure: 250 PSIG
- Exterior Finish: Gray Powder Coat
- Orifice Size: .170" (Compact) & .219" (Full)
- Seat Material: Fluorocarbon (FKM)
- Diaphragm: Fabric Reinforced NBR/Molded Lip O-Ring Bonnet Body Seal
- Relief Type: Internal Relief - Spring Loaded
- Bonnet / Body Material: Die Cast Aluminum
- Listings: cUL_{US} / UL 144
- Mounting Holes: Standard 3-1/2" Center
- Pressure Taps: #54 Orifice, 1/8" FNPT, Plugged (3)
- Relief Travel Stop: Molded in Adjustment Cap - Gray (Compact), Black (Full Size)



Part No.	Type	Capacity in BTU/H LPG ⁽¹⁾	Inlet	Outlet	Vent Port	Outlet Adj. Range ("WC)	Outlet Set Point ("WC)
MEGR-1232-BBF	Compact	450,000	1/4" FNPT	1/2" FNPT	3/8" FNPT	9.5-13	11
MEGR-1232-BBFXA ⁽²⁾	Compact	450,000	1/4" FNPT	1/2" FNPT	3/8" FNPT	9.5-13	11
MEGR-1232-HBF	Compact	450,000	F. POL	1/2" FNPT	3/8" FNPT	9.5-13	11
MEGR-1232-HBFXA ⁽²⁾	Compact	450,000	F. POL	1/2" FNPT	3/8" FNPT	9.5-13	11
MEGR-1632-BCF	Full Size	700,000	1/4" FNPT	1/2" FNPT	3/4" FNPT	9-13	11
MEGR-1632BCFXA ⁽²⁾	Full Size	700,000	1/4" FNPT	1/2" FNPT	3/4" FNPT	9-13	11
MEGR-1632-CFF	Full Size	950,000	1/4" FNPT	3/4" FNPT	3/4" FNPT	9-13	11
MEGR-1632-CFFXA ⁽²⁾	Full Size	950,000	1/4" FNPT	3/4" FNPT	3/4" FNPT	9-13	11
MEGR-1632-HCF	Full Size	700,000	F. POL	1/2" FNPT	3/4" FNPT	9-13	11
MEGR-1632-HCFXA ⁽²⁾	Full Size	700,000	F. POL	1/2" FNPT	3/4" FNPT	9-13	11
MEGR-1632-JFF	Full Size	900,000	F. POL	3/4" FNPT	3/4" FNPT	9-13	11
MEGR-1632-JFFXA ⁽²⁾	Full Size	900,000	F. POL	3/4" FNPT	3/4" FNPT	9-13	11

(1) Based on 30 PSIG inlet pressure and 20% droop
 (2) Indicates regulator vents opposite pressure tap ports

Excelsior-Flo 2 PSI Second Stage Service Regulators

These 2 PSI service regulators are used to reduce outlet pressures from first stage regulators (normally 10 PSI) to a nominal 2 PSI. 2 PSI service regulators are used in conjunction with an LPG line regulator either at the indoor appliance or a remote manifold distribution header inlet. All MEC 2 PSI service regulators are white with white adjustment caps. The full size 2 PSI service regulators have 3/4" FNPT tapped vents and our exclusive E-Z grip screens located over the inlet. All MEC 2 PSI service regulators feature a stainless steel inlet filter screen to reduce debris from passing through the regulator. Both the MEGR-1622E and MEGR-1652E series offer optimal relief performance that exceeds UL test requirements. All MEC Excelsior-Flo domestic regulators feature a 25 year recommended replacement life and our exclusive tear away leak check adhesive sticker.



MEGR-1622E Series:

Offers a full size high capacity molded lip fabric reinforced diaphragm, stainless steel internal components, fluorocarbon (FKM) seat discs, precision machined aluminum orifices, and an adjustment range from 1.0-2.2 PSI (factory set @ 2 PSI) providing superior downstream regulation and maximum corrosion resistance against weather or contaminated gas.

Regulator Specifications

- Type: Second Stage 2 PSI
- Max. Inlet Pressure: 10 PSI
- Exterior Finish: White Powder Coat
- Orifice Size: .219"
- Seat Material: Fluorocarbon (FKM)
- Diaphragm: Fabric Reinforced (NBR) / Molded Lip O-Ring Bonnet/Body Seal
- Relief Type: Internal Relief - Spring Loaded
- Bonnet / Body Material: Die Cast Aluminum
- Listings: cUL_{US} / UL 144
- Mounting Holes: Standard 3-1/2" Center
- Pressure Taps: #54 Orifice, 1/8" FNPT, Plugged (2)
- Relief Travel Stop: Molded in Adjustment Cap - White



MEGR-1652E Series:

Offers all of the same features as the MEGR-1622E Series but with a rear discharge back mount outlet for convenient wall mount applications.

Part No.	Type	Capacity in BTU/H LPG ⁽¹⁾	Inlet	Outlet	Vent Port	Outlet Adj. Range (PSI)	Outlet Set Point (PSI)
MEGR-1622E-BCH	Full Size	1,100,000	1/2" FNPT	1/2" FNPT	3/4" FNPT	1.0-2.2	2
MEGR-1622E-DCH	Full Size	1,400,000	3/4" FNPT	3/4" FNPT	3/4" FNPT	1.0-2.2	2
MEGR-1652E-DFH ⁽²⁾	Back Mount	1,300,000	3/4" FNPT	3/4" FNPT	3/4" FNPT	1.0-2.2	2

(1) Based on 10 PSIG inlet pressure and 20% droop.

(2) Indicates back mount configuration.



Tested in the U.S.A

Excelsior-Flo Automatic Changeover Domestic Regulators

These Two Stage Automatic Changeover regulators combine the first and second stage regulator into one unit converting full tank pressure to 11" WC. MEC Excelsior-Flo Automatic Changeover regulators prevent gas outages by switching supply cylinders over to the reserve cylinder automatically when the primary cylinder is near empty. When the primary cylinder is depleted causing the changeover to occur a red indicator will appear signifying the reserve cylinder is now in use and the primary cylinder can be refilled without loss of service.

MEGR-175CS61222-BAF Series: Offers a compact two stage regulator option for lower BTU applications such as mobile or seasonal homes. They feature a second stage adjustment from 8-14" WC (factory set @ 11" WC), stainless steel internal components, fluorocarbon (FKM) seat discs, molded lip fabric reinforced diaphragms, and large precision machined aluminum orifices providing superior downstream regulation and maximum resistance against weather or contaminated gas. The compact second stage features a 3/8" FNPT drip lip vent.

MEGR-175CS61622-BCF Series: Offers all of the same features as the compact MEGR-175S61222 series but with a full size high capacity second stage regulator option. The full size second stage diaphragm provides superior downstream regulation and features heavy duty wrench flats and a large 3/4" FNPT tapped drip lip vent to help prevent relief vent blockage. This regulator is perfect for manufacturing larger tanks together such as 420 LB cylinders.

Regulator Specifications

- Type: Automatic Changeover Two-Stage
- Max. Inlet Pressure: 250 PSIG
- Exterior Finish: Gold / Green Powder Coat
- Orifice Size: .140" (Compact) & .219" (Full)
- Seat Material: (NBR) 1st Stage, Fluorocarbon (FKM) 2nd S
- Diaphragm: Fabric Reinforced (NBR) / Molded Lip O-Ring Bonnet/Body Seal
- Relief Type: Internal Relief - Spring Loaded
- Bonnet / Body Material: Die Cast Zinc/Plastic 1st Stage, Die Cast Aluminum 2nd Stage
- Listings: _cUL_{us} / UL 144 2nd Stage
- Mounting Holes: Standard 3-1/2" Center
- Pressure Taps: #54 Orifice, 1/8" FNPT, Plugged (1)
- Relief Travel Stop: Molded in Adjustment Cap - Gray (Compact), Black (Full Size)

MEGR-175CS61222-BAF



MEGR-175CS61622-BCF



Tested in the U.S.A



Part No.	Type	Primary Cylinder Capacity in BTU/H LPG ⁽¹⁾	Auxiliary Cylinder Capacity in BTU/H LPG ⁽¹⁾	Inlet	Outlet	Outlet Adj. Range ("WC)	Outlet Set Point ("WC)
MEGR-175CS61222-BAF	Compact	400,000	340,000	1/4" IF (2)	1/2" FNPT	9.5-13	11
MEGR-175CS61622-BCF	Full Size	650,000	570,000	1/4" IF (2)	1/2" FNPT	9-13	11

(1) Based on 30 PSIG inlet pressure and 20% droop

Excela-Flo Automatic Changeover Regulators

The MEGR-253 Series Automatic Changeover regulators automatically redirect LP gas vapor flow from an empty service cylinder to a reserve cylinder, without interruption of service. It features an easy to read green indicator which changes to red when the service cylinder needs to be refilled.

The MEGR-253 and MEGR-293H Series regulators meet UL, RVIA and NFPA requirements.



MEGR-253
Automatic Changeover
Regulator



MEGR-253H
High Capacity
Automatic Changeover Regulator



MEGR-900
Z-Mounting Bracket



MEGR-RVB
L-Mounting Bracket



MEGR-862
Automatic Changeover
Regulator Cover for MEGR-253 &
MEGR-291 Series Regulators

Regulator Specifications

- Type: Two Stage
- Max Inlet Pressure: 250 PSI
- Inlet Connection: 1/4" Female Inverted Flare (2)
- Outlet Connection: 3/8" FNPT (1)
- Exterior Finish: Raw Zinc (MEGR-253), Powder Coat (MEGR-253H)
- Diaphragm: Fabric Reinforced Molded with O-Ring Bonnet / Body Seal
- Relief Type: Internal Relief - Spring Loaded
- Bonnet / Body Material: Die Cast Zinc
- Listings: ULLISTED / UL 144
- Mounting Holes: 3-1/2" On Center
- Pressure Taps: 1/8" FNPT, Plugged (1)

Part No.	Description	Primary Cylinder BTU/Hr.**	Reserve Cylinder BTU/Hr.**	Covers	Mounting Bracket
MEGR-253*	2 Stage Auto Changeover Regulator 1/4" Inv. Flare x 3/8" FPT	225,000	150,000	MEGR-862	MEGR-900 or MEGR-RVB
MEGR-253H*	High Capacity 2 Stage Auto Changeover Regulator 1/4" Inv. Flare x 3/8" FPT	350,000	200,000		

* Packaged option consists of a plastic clamshell with barcode. To order add "P" at the end of the part number i.e. MEGR-253P

** BTU/H Capacity @ 20% Droop

Note: MEGR-253 and MEGR-253H set point: 100 PSIG Inlet @ 11" WC outlet Flowing @ 30 SCFH Air

Excela-Flo Compact Integral Two Stage Regulators



MEGR-291
Compact Regulator
with Drip Lip Vent



MEGR-295
MEGR-291 with Hard-Nose
Excess FlowPOL

MEGR-291H
High Capacity Regulator
with Drip Lip Vent



MEGR-300
2 PSI Regulator
with Drip Lip Vent



Regulator Specifications

- Type: Two Stage
- Max. Inlet Pressure: 250 PSI
- Inlet Connection: 1/4" FNPT
- Outlet Connection: 3/8" FNPT
- Exterior Finish: Raw Zinc / Powder Coated
- Diaphragm: Fabric Reinforced Molded with O-Ring Bonnet / Body Seal
- Diaphragm Type: Internal Relief - Spring Loaded
- Bonnet/ Body Material: Die Cast Zinc
- Listings: ULLISTED / UL 144
- Mounting Holes: 3-1/2" On Center
- Pressure Taps: 1/8" FNPT Plugged

The MEC MEGR-291 two-stage regulators are approved for use in nearly all portable applications and outdoor cooking appliances utilizing low pressure. They feature all zinc body construction, high and low 1/8" NPT pressure tap ports, an integral second stage drip lip vent and optional standard or 90 degree vent locations.

The MEGR-291H High Capacity Compact Integral Two Stage Regulator is ideally suited for high demand RV, outdoor appliances, cabins, seasonal homes, gas fire places, water heaters, ranges or other moderate to low demand domestic home installations. (Green bonnet identifies high capacity model).

The MEGR-300 Compact Integral Two Stage 2 PSI Regulator is ideally suited for installations to reduce tank pressure to a nominal 2 PSI outlet pressure. 2 PSI systems typically incorporate a line service regulator within the home that further reduces the 2 PSI system pressure to approximately 11" WC prior to the appliance. (Red bonnet identifies 2 PSI model).

The MEGR-291, MEGR-291H and MEGR-300 Series regulators meet UL, RVIA and NFPA requirements.

Part No.	Description	BTU/H LPG @ 30 PSI Inlet*	Accessories
MEGR-291	Compact 2 Stage Regulator 1/4" FNPT Inlet x 3/8" FNPT Outlet	175,000	MEGR-900 (Z-Bracket)
MEGR-298	Compact 2 Stage Regulator 1/4" FNPT Inlet x 3/8" FNPT Outlet - 90° Vent	175,000	
MEGR-295	Compact 2 Stage Regulator HN Excess Flow POL Inlet x 3/8" FNPT Outlet - 90° Vent	175,000	
MEGR-291-20681	Compact 2 Stage Regulator Green Type I QCC Inlet x 3/8" FNPT Outlet	175,000	
MEGR-298-20681	Compact 2 Stage Regulator Green Type I QCC Inlet x 3/8" FNPT Outlet - 90° Vent	175,000	MEGR-861 (1st Stage Cover)
MEGR-291H	Compact 2 Stage High Capacity Regulator 1/4" FNPT Inlet x 3/8" FNPT Outlet	225,000	
MEGR-298H	Compact 2 Stage High Capacity Regulator 1/4" FNPT Inlet x 3/8" FNPT Outlet - 90° Vent	225,000	
MEGR-295H	Compact 2 Stage High Capacity Regulator HN Excess Flow POL Inlet x 3/8" FNPT Outlet - 90° Vent	225,000	MEGR-862 (2nd Stage Cover)
MEGR-291H-20681	Compact 2 Stage High Capacity Regulator Green Type I QCC Inlet x 3/8" FNPT Outlet	225,000	
MEGR-298H-20681	Compact 2 Stage High Capacity Regulator Green Type I QCC Inlet x 3/8" FNPT Outlet - 90° Vent	225,000	
MEGR-300	Compact 2 Stage 2 PSI Regulator 1/4" FNPT Inlet x 3/8" FNPT Outlet	225,000	
MEGR-300-90	Compact 2 Stage 2 PSI Regulator 1/4" FNPT Inlet x 3/8" FNPT Outlet - 90° Vent	225,000	

MEGR-291 and MEGR-291H setpoint: 100 PSIG Inlet @ 11" WC Outlet Flowing @ 30 SCFH Air

MEGR-300 setpoint: 100 PSIG Inlet @ 2 PSI Outlet Flowing @ 30 SCFH Air

* BTU/H Capacity @ 20% Droop



EXCELA-FLO Low Pressure Single Stage Regulators

The MEGR-230 single-stage regulators are approved for use in small portable applications and outdoor cooking appliances utilizing low pressure.

Note: Single-stage regulators are not approved for RV use.

Regulator Specifications

- Type: Single Stage
- Orifice Diameter: 0.059 Diameter
- BTU Capacity: 140,000 BTU (based on 25 PSI inlet @ 9 W.C. delivery pressure)
- Max. Inlet Pressure: 250 PSI
- Inlet Connection: 1/4" FNPT
- Outlet Connection: 3/8" FNPT
- Exterior Finish: Green Wet Coat
- Diaphragm Type: Molded with O-Ring Bonnet / Body Seal
- Bonnet/Body Material: Die Cast Aluminum
- Listings: UL LISTED / UL 144
- Mounting Holes: 3-1/2" On Center



MEGR-230



MEGR-230-9

Part No.	Description	Vent Orientation
MEGR-218	Single Stage Regulator - SN FF POL w/ Plastic Handwheel x 3/8" FNPT - 90° Vent	90°
MEGR-230	Single Stage Regulator - 1/4" FNPT Inlet X 3/8" FNPT Outlet	Over Outlet
MEGR-230-9	Single Stage Regulator - SN .9 GPM Excess Flow POL Inlet x 3/8" FNPT Outlet	Over Outlet
MEGR-230-90	Single Stage Regulator - 1/4" FNPT Inlet X 3/8" FNPT Outlet - 90° Vent	90°
MEGR-230-1618	Single Stage Regulator - Black F. QCC Inlet x 3/8" FNPT Outlet - 90° Vent	90°
MEGR-230-1326	Single Stage Regulator - Black F. QCC Inlet (100,000 BTU/ H) x 3/8" FNPT Outlet	Over Outlet
MEGR-231	Single Stage Regulator - Hardnose FF POL Inlet x 3/8" FNPT Outlet - 90° Vent	90°

Excela-Flo Pressure Reducing Regulators

The MEGR-1912 Series UL Listed regulators are direct-operated, spring-loaded models designed for use in a variety of service and industrial applications. These regulators have limited-capacity internal relief across the diaphragm to help minimize over pressurization.

The MEGR-1912 Series with capacity ratings of less than 320,000 BTU/hr (129 scfh), are often used on small portable outdoor appliances.

Underwriters Laboratories requires horizontally mounted regulators to be installed with vent opening protection to prevent blockage by freezing rain.

Regulator Specifications

- Type: Single Stage
- Max. Inlet Pressure: 250 PSI
- Vent Screen: Monel
- Gasket: CGR 2750
- Relief Valve: Brass and Zinc
- Control and Relief Valve Spring: Plated Steel
- Diaphragm Assembly: Nitrile (NBR) with Zinc disk
- Spring Case: Die Cast - Zinc
- Spring Seat: Plated Steel
- Diaphragm Plate: Plated Steel
- Body Material / Lower Casting: Die Cast - Zinc
- Listings: UL LISTED / UL 144



**MEGR-1912
SERIES**



Part No.	Inlet x Outlet Connection Style	Orifice Sizes, Inches (mm)	Outlet Pressure Setting	Outlet Pressure Ranges, Inches W.C. (mbar)	Vent Orientation	BTU/H LPG @ 100 PSI Inlet
MEGR-1912/101	1/4" x 3/8" FNPT	0.073 (1,8)	11-inches w.c. (27 mbar)	9.25 to 13 (23 to 32)	Over Outlet	242,953
MEGR-1912/104	1/4" x 1/4" FNPT	0.073 (1,8)	11-inches w.c. (27 mbar)	9.25 to 13 (23 to 32)	Over Outlet	242,953
MEGR-1912/109	1/4" x 3/8" FNPT	0.073 (1,8)	7-inches w.c. (17 mbar)	5 to 10 (12 to 25)	Over Outlet	242,953
MEGR-1912/197	1/4" x 3/8" FNPT	0.094 (2,4)	20-inches w.c. (50 mbar)	12 to 24 (30 to 60)	Over Outlet	313,488
MEGR-1912H/108	1/4" x 3/8" FNPT	0.094 (2,4)	1.5 PSI (103 mbar)	0.5 to 2.7 psi (34 to 186 mbar)	Over Outlet	297,814
MEGR-1912H/520	1/4" x 1/4" FNPT	0.094 (2,4)	3.5 PSI (241 mbar)	2.7 to 5 psi (186 to 345 mbar)	Over Outlet	----
MEGR-1912H/534	1/4" x 1/4" FNPT	0.073 (1,8)	1.5 PSI (103 mbar)	0.5 to 2.7 psi (34 to 186 mbar)	Over Outlet	----
MEGR-1912N/113	1/4" x 3/8" FNPT	0.073 (1,8)	5-inches w.c. (27 mbar)	3 to 7 (7 to 17)	Over Outlet	----
MEGR-1912N/194	1/4" x 1/4" FNPT	0.073 (1,8)	5-inches w.c. (27 mbar)	3 to 7 (7 to 17)	Over Outlet	----

* Other configurations and materials available upon request



Excela-Flo High Pressure LP Gas Regulators

The MEGR-130 series fixed high pressure single stage regulators are designed to provide an economical solution for pounds to pounds service applications. The MEGR-130 can be used to regulate air as well as LP gas. Regulators must be installed in compliance with federal, state or local codes or laws in accordance with NFPA 58.

The MEGR-350 is a single stage, adjustable high pressure regulator. The body and bonnet of both the fixed and adjustable regulators are precisely machined and feature a crimped design and fabric reinforced rubber diaphragm creating a positive seal for leak-free performance.

The MEGR-360 with the Type I (QCC) is designed specifically for appliances such as turkey fryers, fish fryers, camp stoves and torch applications that require pounds to pounds pressure instead of inches water column. These regulators will meet or exceed most requirements on a specific outlet setting (0-10 PSI) depending on the application.

Regulator Specifications

- Type: Adjustable or Fixed / PSI
- Max. Inlet Pressure: 250 PSIG (17,2 bar)
- Inlet Connection: 1/4" FNPT
- Outlet Connection: 1/4" FNPT
- Orifice Diameter: 0.0625"
- Exterior Finish: Red Anodized
- Diaphragm: Fabric Reinforced Buna N
- Bonnet/Body Material: Die Cast Zinc
- BTU / H Capacity: 1,200,000 BTU/H @ 40 PSI
- Listings: UL LISTED / UL 144



MEGR-130-20
Pre-Set at 20 PSIG



MEGR-350
Adjustable 0-10 PSIG

Part No.	Description
MEGR-130-05	Compact High Pressure Fixed Reg 5 PSI - 1/4" FNPT Inlet/Outlet
MEGR-130-10	Compact High Pressure Fixed Reg 10 PSI - 1/4" FNPT Inlet/Outlet
MEGR-130-20	Compact High Pressure Fixed Reg 20 PSI - 1/4" FNPT Inlet/Outlet
MEGR-130-30	Compact High Pressure Fixed Reg 30 PSI - 1/4" FNPT Inlet/Outlet
MEGR-350	Compact High Press. Adjustable Reg 0-10 PSI - 1/4" FNPT Inlet/Outlet
MEGR-350-20	Compact High Press. Adjustable Reg 0-20 PSI - 1/4" FNPT Inlet/Outlet
MEGR-350-30	Compact High Press. Adjustable Reg 0-30 PSI - 1/4" FNPT Inlet/Outlet
MEGR-351	Compact High Pressure Adjustable Reg 0-10 PSI - Full Flow POL x 1/4" FNPT
MEGR-360	Compact High Pressure Adjustable Reg 0-10 PSI - Black F. QCC x 1/4" FNPT

Excela-Flo High Pressure Regulators

The MEGR-6120 Series are UL listed high-pressure regulators that meet a variety of applications for liquid or vapor service. The compact body design makes these regulators particularly useful in installations with space limitations. The basic MEGR-6120 Series regulators come equipped with a handwheel adjustment. The non-adjustable ME6121 Series provides a tamper-resistant spring case and one of seven fixed set points: 5, 10, 20, 30, 40, 50, or 60 PSI.

The MEGR-6120 & MEGR-6121 Series are UL listed as high pressure, non-relief regulators. Both MEGR-6120 & MEGR-6121 Series regulators contain brass materials that are **not** compatible with anhydrous ammonia service.

Regulator Specifications

- Type: Adjustable or Fixed / PSI
- Max. Inlet Pressure: 250 PSI (17, 2 bar)
- Inlet Connection: 1/4" FNPT
- Outlet Connection: 1/4" FNPT
- Gauge Port: 1/4" FNPT
- Exterior Finish: Red Wet Coat
- Diaphragm: Fabric Reinforced Buna N
- Body / Bonnet Material: Die Cast Aluminum
- Liquid Capacity: 3-5 GPH
- Listings: UL LISTED / UL 144

MEGR-6120 Series



MEGR-6121 Series



Adjustable Configurations	
Part No.	Description
MEGR-6120-30	High Pressure Adjustable Reg 1-30 PSI - 1/4" FNPT Inlet/Outlet
MEGR-6120-60	High Pressure Adjustable Reg 1-60 PSI - 1/4" FNPT Inlet/Outlet
MEGR-6120-100	High Pressure Adjustable Reg 1-100 PSI - 1/4" FNPT Inlet/Outlet

Non-Adjustable Configurations	
Part No.	Description
MEGR-6121-05	High Pressure Fixed Reg 5PSI - 1/4" FNPT Inlet/Outlet
MEGR-6121-10	High Pressure Fixed Reg 10PSI - 1/4" FNPT Inlet/Outlet
MEGR-6121-20	High Pressure Fixed Reg 20PSI - 1/4" FNPT Inlet/Outlet
MEGR-6121-30	High Pressure Fixed Reg 30PSI - 1/4" FNPT Inlet/Outlet
MEGR-6121-40	High Pressure Fixed Reg 40PSI - 1/4" FNPT Inlet/Outlet
MEGR-6121-50	High Pressure Fixed Reg 50PSI - 1/4" FNPT Inlet/Outlet
MEGR-6121-60	High Pressure Fixed Reg 60PSI - 1/4" FNPT Inlet/Outlet

CAPACITIES: BTU/H LPG (VAPOR)		
Outlet Set Point	Inlet Pressure	BTU / HR
15 PSI	50 PSI	850,000
15 PSI	100 PSI	1,700,000
15 PSI	150 PSI	2,500,000
20 PSI	50 PSI	900,000
20 PSI	100 PSI	1,800,000
40 PSI	100 PSI	1,500,000
40 PSI	150 PSI	2,000,000
50 PSI	100 PSI	1,300,000
50 PSI	150 PSI	1,800,000
50 PSI	200 PSI	2,300,000

*Approximate BTU/H vapor capacities taking 10-20% droop into consideration

Note: Side Outlet Connection Style (Plugged): 1/4" MNPT, pressure gauge (MEJ500 Series) can be installed

EXCELA-FLO High Pressure Regulators

The MEGR-164 Series adjustable high-pressure regulators offer a wide selection of available pressure ranges. High pressure regulators are typically used to reduce tank pressure to an intermediate pressure for use by another regulator. They may be used as high pressure regulators on distribution systems when used in conjunction with first-stage downstream regulators.

When equipped with an integral relief valve (MEGR-164SR Series), the regulator may be used as a final-stage regulator on high pressure systems. It may also be used as a first-stage regulator when set at 10 PSIG (0,69 bar) or less. The 1/4"-inch FNPT tapped side outlet can be used to install a pressure gauge or a hydrostatic relief valve. This series contains brass materials that are **not** compatible with anhydrous ammonia service.

Regulator Specifications

- Type: Adjustable/ PSI
- Max. Inlet Pressure: 250 PSI
- Inlet Connection: 1/2" FNPT or 3/4" FNPT
- Outlet Connection: 1/2" FNPT or 3/4" FNPT
- Exterior Finish: Gray Urethane
- Regulator Spring: Steel
- Stem Guide/Disk Holder: Stainless Steel
- Diaphragm: Fabric Reinforced Nitrile (NBR)
- Bonnet/Body Material: Cast Aluminum
- Vent: Non-Aluminum
- Listings: UL LISTED / UL 144



MEGR-164 Series



Part No.	Description	Outlet Pressure Setting, PSIG	Outlet Adjustment Range, PSIG	BTU/H * LPG @ 60 PSI Inlet	BTU/H * LPG @ 100 PSI Inlet
MEGR-164/33	1/2" FNPT x 1/2" FNPT Adjustable High Pressure Regulator	10	0-30	6,098,000	6,800,000
MEGR-164/35		20	0-30	6,400,000	8,335,000
MEGR-164/36		40	0-60	6,100,000	9,145,000
MEGR-164/222		50	0-125	4,900,000	7,225,000
MEGR-164SR/21	1/2" FNPT x 1/2" FNPT Adjustable High Pressure Regulator w/ Internal Relief Valve	10	0-15	4,675,000	7,825,000
MEGR-164SR/22		15	0-30	3,050,000	4,125,000
MEGR-164SR/23		20	0-30	3,405,000	4,755,000
MEGR-164-6/33	3/4" FNPT x 3/4" FNPT Adjustable High Pressure Regulator	10	0-30	9,150,000	10,875,000
MEGR-164-6/35		20	0-30	10,105,000	12,400,000
MEGR-164-6/36		40	0-60	9,960,000	13,415,000
MEGR-164-6/222		50	35-100	4,575,000	11,890,000

Note: 1" model also available (MEGR-164-8). Please contact factory for more information.

* BTU/H Capacity @ 20% Droop

EXCELA-FLO High Pressure Regulator

The MEGR-11301F is a reliable and accurate regulator making it ideal for numerous high pressure applications. This multi-purpose regulator can be used as a pilot supply or pressure-loading regulator where high pressure operating medium must be reduced for use by gas regulator pilots or pressure-loaded regulators. Its rugged design and multiple outlet ports offer versatility for a wide variety of applications.

Regulator Specifications

- Type: Adjustable / PSI
- Max. Inlet Pressure: 5500 PSIG
- Inlet Connection: 1/4" FNPT (1 Port)
- Outlet Connection: 1/4" FNPT (3 Ports)
- Exterior Finish: Brass
- Bonnet / Body Material: Brass
- Bottom Cap and Spring Case: Brass
- Gasket: Nitrile (NBR)
- Valve Spring: Stainless Steel
- Diaphragm: Stainless Steel
- Valve Disks: Nylon
- Vent: 4 Holes (5/32" each)
- Temp. Range: -40° F. / 225° F.



Part No.	Description	Inlet (1 Port)/ Outlet (3 Ports)	Outlet Pressure Range (PSIG)
MEGR-11301F	High Pressure Regulator	1/4" FNPT	0-120

EXCELA-FLO Liquid Backpressure Regulator/Relief

The MEGR-198H Series, liquid service valves are direct-operated relief valves for use on relief and backpressure applications involving large LP-Gas pumping systems and vaporizers. Internal pressure registration eliminates the need for a control line.

Regulator Specifications

- Type: Adjustable / PSI
- Orifice Material: Stainless Steel
- Max. Inlet Pressure: 250 PSIG
- Regulator Spring: Plated Steel
- O-Ring Seat: Nitrile (NBR)
- Exterior Finish: Gray Powder Coat
- Diaphragm: Neoprene
- Body Material / Spring Case: Iron



**MEGR-198H
Series**

Part No.	Inlet/Outlet Size	Relief Pressure Setting PSIG (BAR)	Outlet Range PSIG (BAR)	Relief Capabilities GPM/LPG	
				10 PSI Over Set Point	50 PSI Over Set Point
MEGR-198H-22	3/4" FNPT	100 (6.9)	70 to 140 (4.8 to 9.7)	49	93
MEGR-198H-30	1" FNPT	100 (6.9)	70 to 140 (4.8 to 9.7)	49	93
MEGR-198H-31	1" FNPT	175	130-200	52	109



Excela-Flo

First Stage / High Pressure Industrial Regulators

The MEGR-1627 Series commercial/industrial regulator is a large capacity, high pressure unit for use in conjunction with MEGR-CS1200 or MEGR-S1202 Series regulators. It can also be used on final-stage (PSI to PSI) service. The diaphragm case and/or regulator body on the MEGR-1627 Series can be rotated in any of four positions to allow installation in locations with limited space. Available with a monitor or integral relief valve. The MEGR-1627 Series is perfectly suited for jurisdictional systems, grain dryers, direct fired vaporizers or other high capacity service applications.

The MEGR-1630 Series First Stage / Industrial regulators are large capacity, high pressure units for use in conjunction with MEGR-S1202 Series regulators. They can also be used on final stage (pounds-to-pounds) service. These regulators are best suited for industrial applications where high flow capacity is required.



MEGR-1627 Series



MEGR-1630 Series



Regulator Specifications

- Type: Adjustable / PSI
- Orifice Diameter: 3/8", 5/16" or 1/2"
- Orifice Material: Aluminum
- Max. Inlet Pressure: 250 PSI
- Regulator Spring: Steel
- Stem Guide / Disk Holder: Stainless Steel
- Valve Stem: Steel
- Exterior Finish: Grey Powder Coat
- Diaphragm: Fabric Reinforced Nitrile (NBR)
- Bonnet Cap & Housing/Body Material: Cast Aluminum/ Iron
- Temp. Range: -20° F. / 180° F.
- Listings: UL LISTED / UL 144

Part No.	Description	Inlet/Outlet	Orifice	PSIG Outlet Set Point	PSIG Outlet Range	Monitor	BTU/H LPG @ 100 PSI Inlet	BTU/H LPG @ 20 PSI Inlet
MEGR-1627/497	First Stage High Pressure Regulator	1" FNPT	1/2"	20	15-40	No	36,600,000	6,050,000
MEGR-1627/576		2" FNPT	1/2"	10	5-20	No	45,000,000	6,003,000
MEGR-1627/5810		3/4" FNPT	3/8"	10	5-20	No	11,700,000	4,700,000
MEGR-1627/6210		3/4" FNPT	1/2"	10	5-20	No	12,400,000	6,700,000
MEGR-1627/7710		1" FNPT	1/2"	10	5-20	No	25,100,000	6,900,000
MEGR-1627M/267		2" FNPT	1/2"	10	5-20	Yes	36,100,000	6,003,000
MEGR-1627M/471		1" FNPT	1/2"	10	5-20	Yes	25,100,000	6,900,000
MEGR-1627R/113		3/4" FNPT	3/8"	10	5-20	Relief	9,800,000	4,200,000
MEGR-1627V/7710*		1" FNPT	1/2"	10	5-20	No	25,100,000	6,900,000

* Viton® construction

Part No.	Description	Inlet/Outlet	Orifice	PSIG Outlet Set Point	Outlet PSIG Range	*SCFH/HR LPG	BTU/H LPG @ 100 PSI Inlet	BTU/H LPG @ 20 PSI Inlet
MEGR-1630-104/78	First Stage Regulator	2" FNPT	1/2"	10	8-20	18,900	47,000,000	7,700,000

Note: Other configurations and materials available upon request.

Excela-flo

Second Stage / Low Pressure Industrial Regulators

The **MEGR-S1202/MEGR-CS1200** Series commercial/industrial regulators are large capacity, low pressure second stage units for installation at schools, bakeries, and similar applications. They contain a limited capacity internal relief valve and can be used in conjunction with either MEGR-1627 Series or MEGR-1630 Series high-pressure regulators.

For high capacity installations, the MEGR-1289H Series relief valve is required to be installed in the downstream system.

MEGR-1HSRL Series: Offers a full size high capacity light commercial type regulator with an adjustment range from 6-14" WC (factory set @ 11" WC), a heavy duty cast iron body with a universal body to bonnet union for fast relocation of inlet to outlet vent location. These light commercial second stage regulators are used to reduce outlet pressures from first stage regulators (normally 10 PSI) to 11" WC.

Regulator Specifications

- Type: Adjustable / Inches WC or PSI
- Orifice Diameter: 3/8", 5/16", 1/2" or 1"
- Max. Inlet Pressure: 25 PSIG
- Body Material: Cast Iron
- Regulator Spring: Music Wire
- Spring Case/ Stem Guide/ Disk Holder: Aluminum
- Disk/ Diaphragm and O-Ring: Fabric Reinforced Nitrile (NBR)
- Closing Cap Gasket: Neoprene



MEGR-1HSRL Series



MEGR-CS1200 Series



MEGR-S1202 Series

Part No.	Description	Inlet/Outlet Connection Style	Orifice	Outlet Pressure Range	Outlet Pressure Setting	Maximum Operating Inlet Pressure	BTU/H LPG @ 25 PSI Inlet	BTU/H LPG @ 10 PSI Inlet
MEGR-1HSRL-BFC	Second Stage Low Pressure Regulator	3/4" FNPT	3/8"	6-14" WC	11" WC	40 PSIG	—	2,000,000
MEGR-1HSRL-CFC		1" FNPT	3/8"	6-14" WC	11" WC	40 PSIG	—	2,500,000
MEGR-CS1200IR6EC1		3/4" FNPT	1/2"	6 - 14" WC	11" WC	25 PSIG	2,100,000	1,600,000
MEGR-CS1200IR6EC3		1" FNPT	1/2"				2,500,000	1,900,000
MEGR-CS1200IR6EC6		1-1/4" FNPT	1/2"				3,100,000	2,800,000
MEGR-CS1200IR7EC1		3/4" FNPT	5/16"				*1,250,000	*985,000
MEGR-CS1200IR7EC3		1" FNPT	5/16"		7" WC		*1,620,000	*1,525,000
MEGR-S1202G-BNC		1-1/2" FNPT	1"	9 - 18" WC	11" WC	25 PSIG	14,700,000	10,800,000
MEGR-S1202G-CNC		2" FNPT	1"				30,000,000	23,000,000
MEGR-S1202H-CNK		2" FNPT	1"	1.5-3.25 PSI	2 PSI	25 PSIG	22,200,000	10,300,000

Note: Other configurations and materials available upon request.
WC = Water Column

* Flow Rates listed in BTU Natural Gas



EXCELA-FLO Second Stage / Industrial Regulators

The MEGR-1133 Series Second Stage / Industrial regulators are large capacity, self operated, low or high pressure units for use in applications with loads up to 110,000,000 BTU/H capacity. These regulators are best suited for industrial applications where high flow capacity and a downstream monitor control line are required.



MEGR-1133 Specifications

- Type: Adjustable / PSI / WC
- Orifice Diameter: 2"
- Orifice Material: Aluminum
- Max. Inlet Pressure: 60 PSI
- Regulator Spring: Steel
- Stem Guide/Disk Holder: Aluminum
- Valve Stem: Aluminum
- Exterior Finish: Gray Powder Coat
- Diaphragm: Fabric Reinforced Nitrile (NBR)
- Body Material: Iron
- Bonnet Cap & Bonnet: Aluminum

Part No.	Description	Inlet/Outlet	Orifice	Range of Adjustment	Outlet Set Point	BTU/H LPG @ 10 PSI Inlet	BTU/H LPG @ 20 PSI Inlet
MEGR-1133H-2	Second Stage Regulator	2" FNPT	2"	2-5 PSI	2 PSI	27,405,000	52,700,000
MEGR-1133H-3	Second Stage Regulator	2" FNPT	2"	5-10 PSI	5 PSI	22,300,000	41,600,000
MEGR-1133L-4	Second Stage Regulator	2" FNPT	2"	8.5"-18" WC	14" WC	45,600,000	77,100,000
MEGR-1133L-6	Second Stage Regulator	2" FNPT	2"	.75-2 PSI	2 PSI	46,700,000	77,100,000

Note: Other configurations available upon request

EXCELA-FLO Vapor Backpressure Regulator/Relief Valves

Available in settings ranging between 1 to 75 PSIG, the MEGR-1289H Series relief valve is a throttling relief valve used downstream of pressure regulators to protect the downstream system from overpressure. A smooth throttling action minimizes pressure surges in the system during emergency operation.

This unit features a pilot tube booster to achieve the highest possible relief capacity with a minimum buildup of system pressure.

The MEGR-1289H relief valve is installed between large second stage regulators and the burner to provide high capacity relief. They are ideal for low pressure settings due to the increased sensitivity provided by the large diaphragm area.

MEGR-1289H Specifications

- Type: Adjustable / Inches WC or PSI
- Max. Inlet Pressure: 100 PSIG (1" Body) 25 PSIG (2" Body)
- Spring: Plated Steel
- Exterior Finish: Gray Powder Coat
- Diaphragm: Fabric Reinforced Nitrile (NBR)
- Bonnet/Body Material: 1" - All Aluminum
2" - Aluminum Bonnet / Iron Body



Part No.	Description	Inlet/Outlet	Max. Inlet PSIG	Set Point	Set Point Range	SCFH / Propane
MEGR-1289H/1	Back Pressure Regulator/ Relief Valve	2" FNPT	25	9" WC	7-18" WC	55,000
MEGR-1289H/2	Back Pressure Regulator/ Relief Valve	2" FNPT	25	1 PSIG	.5-2.25 PSIG	55,500
MEGR-1289H/3	Back Pressure Regulator/ Relief Valve	2" FNPT	25	3 PSIG	1.75-7 PSIG	58,000
MEGR-1289H/4	Back Pressure Regulator/ Relief Valve	2" FNPT	25	6 PSIG	4-10 PSIG	58,500
MEGR-1289H/5	Back Pressure Regulator/ Relief Valve	2" FNPT	25	12 PSIG	10-15 PSIG	61,000
MEGR-1289H/41	Back Pressure Regulator/ Relief Valve	1" FNPT	100	2 PSIG	1-4.5 PSIG	45,500
MEGR-1289H/42	Back Pressure Regulator/ Relief Valve	1" FNPT	100	8 PSIG	4-15 PSIG	46,000
MEGR-1289H/43	Back Pressure Regulator/ Relief Valve	1" FNPT	100	15 PSIG	10-20 PSIG	48,000
MEGR-1289H/49	Back Pressure Regulator/ Relief Valve	1" FNPT	100	25 PSIG	15-50 PSIG	49,000
MEGR-1289HH-1	Back Pressure Regulator/ Relief Valve	1" FNPT	100	50 PSIG	45-75 PSIG	50,000
MEGR-1290H/43	Back Pressure Regulator/ Relief Valve	3/4" FNPT X 1" FNPT	100	15 PSIG	10-20 PSIG	40,000
MEGR-1290H/49	Back Pressure Regulator/ Relief Valve	3/4" FNPT X 1" FNPT	100	25 PSIG	15-50 PSIG	50,000

Note: Other configurations and materials available upon request.



Excela-Flo Pilot Operated / Industrial Regulators

The MEGR-199 Series Industrial regulators are large capacity, pilot operated, low or high pressure units for use in applications with loads demanding up to 75,000,000 BTU/H capacity. These regulators are best suited for industrial applications where high flow capacity and a downstream monitor control line can be applied. The MEGR-199 series provides exceptional downstream control while operating at very high capacities with minimal droop under varying flow and inlet pressures.

Regulator Specifications

- Type: Adjustable/PSI/WC
- Max. Inlet Pressure: 150-300 PSI
- Exterior Finish: Gray Powder Coat
- Orifice Size: 7/8" or 1-1/8"
- Orifice Material: Stainless Steel
- Regulator Spring: Steel
- Diaphragm Plate: Steel
- Diaphragm: Fabric Reinforced Nitrile (NBR)
- Body Material: Iron
- Bonnet Cap & Bonnet: Iron



MEGR-199 Series

Part No.	Description	Inlet/Outlet	Max. Pressure	Orifice	Range of Adjustment	Outlet Set Point	BTU/H LPG @ 20 PSI Inlet
MEGR-199-501P	Pilot Operated Low Pressure Regulator	2" FNPT	150	1-1/8"	7" WC-2 PSI	1	48,825,000
MEGR-199-502P	Pilot Operated Low Pressure Regulator	2" FNPT	150	1-1/8"	1-5 PSI	5	55,125,000
MEGR-199-503P	Pilot Operated Low Pressure Regulator	2" FNPT	150	1-1/8"	2-10 PSI	10	61,425,000
MEGR-199-504P	Pilot Operated Low Pressure Regulator	2" FNPT	150	1-1/8"	5-15 PSI	15	63,000,000
MEGR-199-510P	Pilot Operated High Pressure Regulator	2" FNPT	250	7/8"	7" WC-2 PSI	1	29,295,000
MEGR-199-511P	Pilot Operated High Pressure Regulator	2" FNPT	250	7/8"	1-5 PSI	5	33,075,000
MEGR-199-512P	Pilot Operated High Pressure Regulator	2" FNPT	250	7/8"	5-15 PSI	15	37,800,000
MEGR-199-513P	Pilot Operated High Pressure Regulator	2" FNPT	250	7/8"	2-10 PSI	10	36,225,000
MEGR-199-515P	Pilot Operated High Pressure Regulator	2" FNPT	250	7/8"	10-20 PSI	20	40,950,000
MEGR-199-903P	Pilot Operated High Pressure Regulator	2" FNPT	250	7/8"	10-65 PSI	30	44,100,000
MEGR-199-502PH	Pilot Operated High Pressure Regulator	2" FNPT	300	1-1/8"	1-5 PSI	5	55,125,000
MEGR-199-503PH	Pilot Operated High Pressure Regulator	2" FNPT	300	1-1/8"	2-10 PSI	10	61,425,000
MEGR-199-504PH	Pilot Operated High Pressure Regulator	2" FNPT	300	1-1/8"	5-15 PSI	15	63,000,000
MEGR-199-505PH	Monitor Pilot Operated High Pressure Regulator	2" FNPT	300	1-1/8"	10-20 PSI	20	67,725,000
MEGR-199-901PH	Monitor Pilot Operated High Pressure Regulator	2" FNPT	300	1-1/8"	10-65 PSI	30	74,025,000
MEGR-199M-504PH	Monitor Pilot Operated High Pressure Regulator	2" FNPT	300	1-1/8"	5-15 PSI	15	42,650,000
MEGR-199M-505PH	Monitor Pilot Operated High Pressure Regulator	2" FNPT	300	1-1/8"	10-20 PSI	20	67,725,000
MEGR-199M-901PH	Monitor Pilot Operated High Pressure Regulator	2" FNPT	300	1-1/8"	10-65 PSI	30	74,025,000

(1) Capacity based on inlet pressures 20 PSIG greater than outlet pressure set point and 20% droop.



Valve Safety Warning

To ensure the safety of our customers, Marshall Excelsior Company would like to provide you with information regarding the hazards associated with using aging LP-Gas valves and regulators. It is hoped that this bulletin will make clear to LP-Gas dealer managers and service personnel that to avoid serious injury or property damage, careful attention and intense care must be used while installing, inspecting, and maintaining these products.

All Marshall Excelsior Products must be installed and maintained in accordance with NFPA 58 “Liquefied Petroleum Gas Code”, NFPA 59 “Utility LP-Gas Plant Code”, and all other applicable state, federal and local requirements.

In the interest of safety, all persons employed in handling LP-Gases shall be trained in proper handling and operating procedures. This safety bulletin along with NFPA 58 and NFPA 59 can be used in the training of new employees as well as reminding experienced employees of the hazards that can occur.

Nature of Warnings

Although warnings should regularly be as brief as possible, factors involved in filler valve and filling valve failures are very complex. These factors need to be fully understood so that proper procedures and maintenance can be implemented to prevent accidents. In its stripped-down form, the simplest possible warning would be:

Loosen filler valve from filling valve very slowly. If there is a leak, know the procedure(s) to follow.

This bulletin will not cover all safety procedures regarding the installation, operation, and maintenance of LP-Gas systems, and regarding filler valves.

Hose End Filling Valves with Acme Connectors

When reeling the hose, never let the hose end valve be dragged over the ground, dropped or banged into the truck.

If dragged, hose end valves could open accidentally or be damaged. Dragging will cause accelerated/abnormal wear and eventual valve failure, and foreign material will become lodged in the connector, causing failure of the filler valve.

Follow this procedure on every filling application in order to prevent hazardous conditions:

- Wear gloves and eye protection at all times.
- Check hose end valve and filler valve for foreign materials and, if present, remove with extreme care. If foreign material cannot be safely removed, do not proceed with filling and replace valve.
- Make sure the Acme connector easily spins on by hand.
- If a leak is detected when filling is started, immediately stop the operation and follow procedures to correct the leaking condition.
- After filling, bleed the gas trapped between the filler valve and the hose end valve by (a) using the vent on the hose end valve or (b) slightly loosening coupling nut to vent the gas before disconnecting. If the gas does not stop venting, then there is a leak in the filler valve or hose end valve. Do not disconnect filling connector. Follow your company procedure for handling this hazardous situation. Make sure your company has such a procedure.

Inspection of Filling Valves with Handwheel

- All valves should be inspected at least once a month to ensure that the handle is tight and not damaged, the stem is not bent and that there is no “play” in the threads in the bonnet. “Play” will normally not be noticed if the valve is under pressure.
- The seating area should be smooth and clean, and the Acme threads should be checked for wear, dents, or nicks.

Inspection of Quick Acting Filling Valves

- Inspect valves daily to ensure locking mechanism is working properly.
- The seating area should be smooth and clean, and the Acme threads should be checked for wear, dents, or nicks.
- Check the retaining ring on the filler connection to ensure that it is properly holding the female Acme nut or handle so that it protects surface that seats on the filler valve.
- Immediately replace or repair valves if any problems are evident.

Larger Filler and Filling Valves

When dealing with 2-1/4” and 3-1/4” Acme valve connections, only use the special wrenches designed for the purpose.

DO NOT use hammers or pipe wrenches to tighten the connections. All previous warnings about smaller valves also apply to larger valves.

General Warning

Marshall Excelsior products are mechanical devices that are subject to wear, contaminants, corrosion, and aging of components made of materials such as rubber and metal. Over time these devices will eventually become inoperative. The safe service life of these products will reflect the environment and conditions of use that they are subjected to. Regular inspection and maintenance is essential. Marshall Excelsior products have a long record of quality and service, so LP-Gas dealers may forget hazards that can arise from using aging devices that have outlived their safe service life. The length of a device’s life reflects the environment in which it is used, and the LP-Gas dealer knows better than anyone about this environment.

There are developing trends in state legislation and proposed national legislation making the owner of products responsible for replacing products before they outlive their safe service life. LP-Gas dealers should be aware of such legislation as it affects them.

TURBO-FLO LE™ Shutoff Valve

The ME807 **TURBO-FLO LE™** Shut-Off Valve is designed for use with LPG & LH3 Transfer Systems. This revolutionary system provides a safe, ergonomic and efficient solution to transfer applications while increasing productivity and dramatically reducing fugitive product emissions. For use with bobtail, transport, railcar and bulk plant applications.

The ME135 discharge hose adapter allows transport hoses to be adapted to work with the ME807 LE Shutoff Valve while providing a flexible connection in the transport trailer hose bleed down lines.



ME807-16

Transfer System Features

- Reduces product emissions 99.6% over standard valve combinations
- 100% compatible with all existing acme transfer connections
- Heavy duty spring loaded safety latch prevents accidental opening of valve
- Cam operated vapor equalization feature for smooth valve operation
- All stainless internal components
- Factory installed hydrostatic relief valve
- Specially formulated low temperature valve seals for maximum performance and life under all operating conditions
- Integrated Back Check (IBC) feature to allow trapped liquid to be forced back upstream of the valve if liquid is trapped downstream of the valve seat
- Available with brass or steel acme connections
- Designed for bi-directional flow of product
- Integrated pilot feature allows the ME807 to equalize and open only when connected to mating connection ensuring maximum safety.



ME135

Turbo-Flo LE Transfer Valves			
Part No.	Description	Discharge at Disconnect	Material
ME807-16	Low Emission Transfer Valve 2" FNPT x 3-1/4" M. Acme Fixed	.09 CC	Ductile/Brass
ME807S-16	Low Emission Transfer Valve 2" FNPT x 3-1/4" M. Acme Fixed	.09 CC	Ductile/Steel
Replacement Parts & Accessories			
Part No.	Description		
ME135	3-1/4"F.Acme x 2MPT Filler Coupling w/Ring & Discharge Hose-Brass Nut/Steel Stem		
ME806-16	Low Emission Transfer Valve 2" FNPT x 3-1/4" F. Acme Swivel		
ME806S-16	Low Emission Transfer Valve 2" FNPT x 3-1/4" F. Acme Swivel		
ME807CRK	Replacement 3-1/4" M. Acme Adapter Repair Kit (Brass) for ME807 Series		
ME807SCRK	Replacement 3-1/4" M. Acme Adapter Repair Kit (Steel) for ME807 Series		



TURBO-FLO LE™ Transfer System

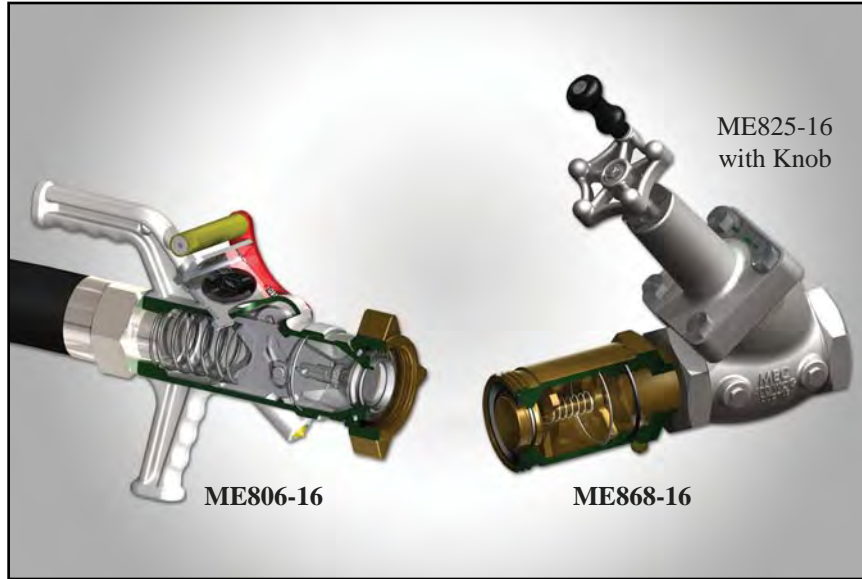

Up to **55%** increased flow when entire system is installed compared to a standard globe valve system

The **TURBO-FLO LE™** (Low Emission) Transfer System is the industries most efficient and cost-effective way to transfer LP-Gas in bobtail, transport, railcar, and bulk plant applications. This product will pay for itself through gas savings during disconnect and its increased flow rate. While any part of this system is interchangeable with other standard systems, to receive maximum savings, all three products (LE Transfer Valve, LE Acme Adapter, and MEC Globe Valve) must be used simultaneously.

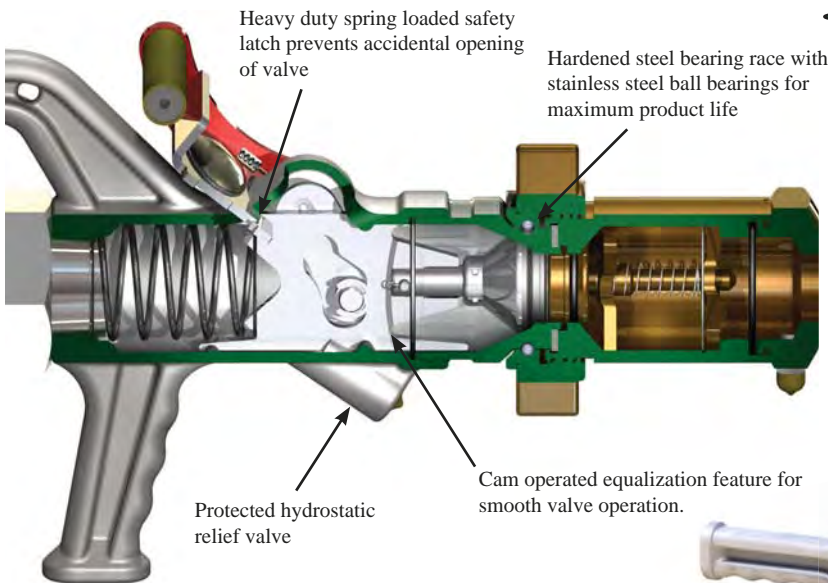

Transfer System Features

- Minimum \$350 Savings per 1,000 fills
- Reduces product emissions by 99.6% over standard valves
- 100% compatible with existing Acme transfer connections
- All stainless steel internal components
- Convenient carrying handles and custom fit dust plug with lanyard (not shown)

Pilot orifice allows the valve to equalize and open only when the valve is attached to the mating part. When the valve is not attached to the mating part, the valve cannot equalize and will not open.

TURBO-FLO LE Transfer Valve				
Part No.	Inlet (FNPT)	Outlet (F. Acme)	Discharge at Disconnect	Material
ME806-16	2"	3-1/4"	.09 CC	Ductile/Brass
ME806S-16*	2"	3-1/4"	.09 CC	Ductile/Steel

* Rated for LP-Gas & NH₃



ME806-16
U.S. Patented
Canada Patent Pending



TURBO-FLO LE™ Transfer System

Turbo-Flo LE Acme Adapters								
Part No.	Inlet (M. Acme)	Outlet (MNPT)	Factory Installed Screen	Discharge at Disconnect	Material	Accessories		
						Mechanical Brake Interlock Retro-Fit	Electronic Proximity Interlock Kit	Back Check Test Adapter
ME866-8	1-3/4"	1"	No	.16 CC	Brass	—	—	—
ME866A-8	1-3/4"	1"	Yes	.16 CC	Brass	—	—	—
ME866-10	1-3/4"	1-1/4"	No	.16 CC	Brass	—	—	—
ME866A-10	1-3/4"	1-1/4"	Yes	.16 CC	Brass	—	—	—
ME867-10	2-1/4"	1-1/4"	No	1.96 CC	Brass	—	—	—
ME867A-10	2-1/4"	1-1/4"	Yes	1.96 CC	Brass	—	—	—
ME868-16*	3-1/4"	2"	No	3.11 CC	Brass	ME868MIB	ME868PIB	MEP105
ME868A-16*	3-1/4"	2"	Yes	3.11 CC	Brass	ME868MIB	ME868PIB	MEP105
ME868-24*	3-1/4"	3"	No	3.11 CC	Brass	ME868MIB	ME868PIB	MEP105
ME868A-24*	3-1/4"	3"	Yes	3.11 CC	Brass	ME868MIB	ME868PIB	MEP105

* Not for use in conjunction with soft seat back check



ME868-16
U.S. Patented
Canada Patent Pending

To determine payback and cost savings visit www.marshallexcelsior.com

TURBO-FLO LE™ Transfer System Accessories

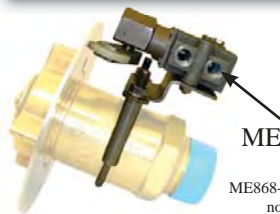

ME868MIB

ME868-16 & ME441F8 not included



ME868BLK



MEP105



ME868PIB
Patent Pending

ME868-16 & ME441F8 not included

ME868BLK – “Bypass Line Kit” is used to create a one-way closed loop between the upstream and downstream sides of a Marshall Excelsior 2” globe valve when used in conjunction with a ME868 Series low emission Acme adapter. The kit features a brass one-way check valve and preformed heavy wall copper tubing with brazed end fittings for durability. This product is intended to prevent over pressurization of the ME868 Series low emission Acme adapters making them truly low emission. This product will also greatly reduce pressures within the ME868 Series adapters thereby decreasing any wear that may occur to the shutoff valves or the low emission Acme adapter.

ME868MIB – “Mechanical Interlock Bracket” allows for a standard Parker style pneumatic air roller valve normally used in conjunction with standard bobtail brake interlock systems to be retro-fit to the ME868 Series low emission Acme adapters. This bracket system allows the standard brake interlock system and connections to be moved forward to the end of the low emission adapter where normal contact with the ME441F8 flange Acme cap can occur. The kit includes all bracketing and mounting hardware. (Kit does not include Parker style pneumatic roller valve)

ME868PIB – “Proximity Interlock Bracket” uses the new MEC smart interlock technology designed to connect with the Allison automatic transmission “auxiliary function range inhibit” preventing operation of the bobtail while this connection is in use. MEC smart interlock technology incorporates a high grade TURCK proximity switch that senses the presence of the stainless steel flange on the ME441F8 Acme cap when secured tightly to the ME868 Series low emission Acme adapter. This kit comes complete with all mounting hardware, MEC smart interlock technology and wiring harness to reach 5’ below the deck of the bobtail.

MEP105 – This adapter allows for the periodic evacuation and testing of a bobtail’s internal back check valve during five year inspection requirements. The adapter fits snugly into the female Acme side of a ME130 which then can be threaded onto the ME868 Series low emission Acme adapter pushing the valve poppet to the open position thereby depressurizing the system for testing purposes. (Note: Be sure to consult instruction manual supplied with MEP105 test adapter before attempting use.)



High Flow Globe & Angle Valves

Marshall Excelsior offers three types of globe and angle valves (standard, integrated pilot feature (P) or integrated back check feature (IBC)) depending on the intended application. All Marshall Excelsior globe and angle valves are designed to withstand extreme temperatures and can **increase flow up to 70 percent** over a standard globe valve. The 35 degree seat angle on the 1-1/4" and larger globe valves make them ergonomically designed for bobtail, transport and bulk plant applications. This 35 degree seat angle also allows up to 70 percent more flow. The 1-1/4" and larger globe and angle valves have an optional 360 degree rotating ME829 **E-ZTurn** knob

To increase the longevity of the seal, all Marshall Excelsior globe and angle valves have a 360 degree rotating seal that stops rotating when it contacts the sealing surface while the valve continues to be tightened. The 1-1/4" and larger models feature ball bearings to facilitate increased seal life.

All 1-1/4" and larger globe and angle valves come with an upstream and downstream plugged port. The boss of these ports are large enough to drill and tap a 3/4" FNPT hole for a jumper line or standard by-pass valve.

These valves are mainly used in piping systems to control liquid or vapor flow in bulk plants, bobtails, transports, pumps or compressors. Globe valves are designed to be installed in a straight section of piping and angle valves are designed to be installed when a 90 degree directional change is needed in the piping.

Change the sealing compound and Marshall Excelsior's globe and angle valves can be used in numerous industries including, but not limited to LP-Gas, anhydrous ammonia, petrochemical and chemical applications. The standard seal compound is Nitrile with Teflon® or Viton® also available. Contact us if you have a need for a different seal compound.

Marshall Excelsior valves are designed to be hand tightened. Using wrenches or excess force to open or close the valve can cause damage to the seal, decreasing the valve's life.

Installation Note: Before installing a globe or angle valve, the piping system and container must be free of dirt, debris, foreign matter and other particles, large or small, that could damage the sealing surface or seal of the valve. A minimal amount of pipe sealant should be used on the mating part. Excess pipe sealant can also cause damage to the seal surface or seal. Damage to the sealing surface or the seal will cause the valve to leak.

To avoid damage to the valve or piping, due to pressure build-up from temperature changes, a hydrostatic relief valve should be installed where liquid can be trapped between two shutoff valves.

A vent valve should be installed on the downstream side of the globe or angle valve if the angle valve is used as a shutoff valve at the end of a loading hose. This allows the operator to vent the trapped liquid before disconnect.

Teflon® is a trademark of DuPont Company and Viton® is a trademark of DuPont Performance Elastomers

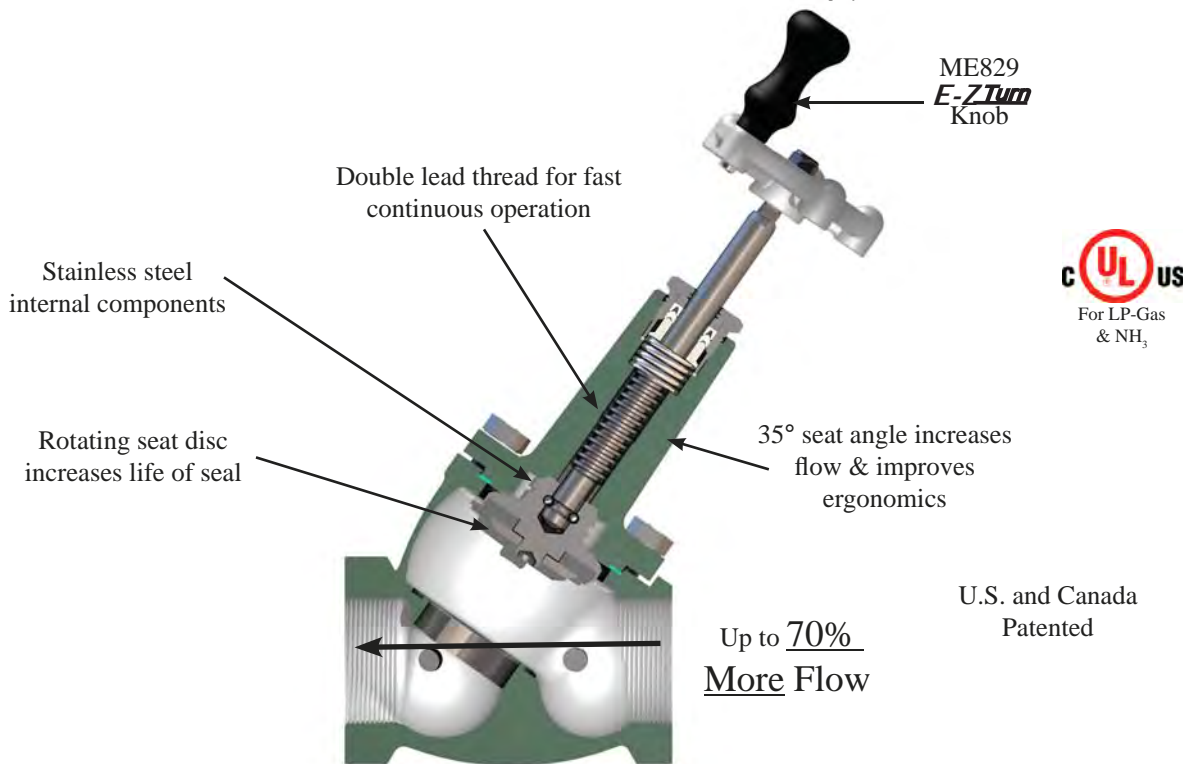

High Flow Globe & Angle Valves

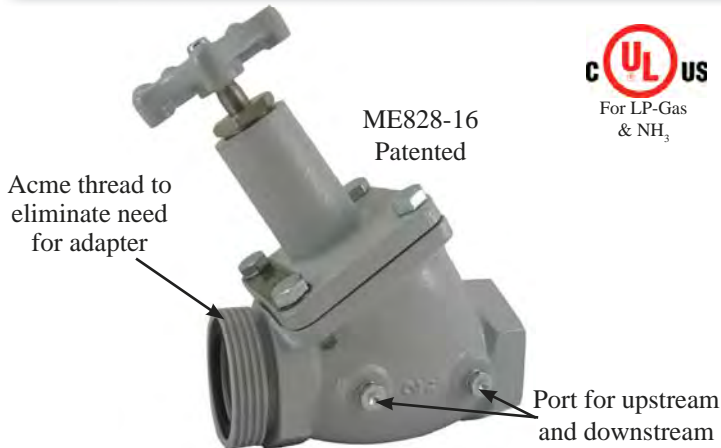

High Flow Globe and Angle Valve Features

- All stainless steel internal components with rotating seat disc design & V-cup Teflon® packing stem seals
- Double stem seal design ensures leak free operation
- Double lead stem thread ensures quick and efficient operation
- Durable ductile iron valve body with automotive grade powder coat finish
- 1-1/4" & larger globe valves have 35° seat angle for maximum product flow
- 1-1/4" & larger globe valve designed ergonomically correct for bobtail transport and bulk plant applications
- 1-3/4", 2-1/4" & 3-1/4" Acme threads available on globe valves
- Rated for 400 WOG
- Operating temperature -40° to +212° Fahrenheit

Part No.		Inlet (FNPT)	Outlet	Side Port (FNPT)	No. of Side Ports	Flange Style Bonnet	Accessories			
Angle	Globe						E-Z Turn Knob	Push-To-Turn Locking Handwheel Kit	Hydrostatic Relief Valves	Vent Valves
ME815-4	ME825-4	1/2"	1/2" FNPT	1/4"	2	No	—	—	MEH225 MEH225SS MEH25/450	MEJ400 MEJ400SC MEJ402S
ME815-6	ME825-6	3/4"	3/4" FNPT	1/4"	2	No	—	—		
ME815-8	ME825-8	1"	1" FNPT	1/4"	2	No	—	—		
ME815-10	ME825-10	1-1/4"	1-1/4" FNPT	1/4"	2	Yes	ME829	ME815-16LHK		
—	ME826-10	1-1/4"	1-3/4" M. Acme	1/4"	2	Yes	ME829	ME815-16LHK		
—	ME827-10	1-1/4"	2-1/4" M. Acme	1/4"	2	Yes	ME829	ME815-16LHK		
ME815-12	ME825-12	1-1/2"	1-1/2" FNPT	1/4"	2	Yes	ME829	ME815-16LHK		
ME815-16	ME825-16	2"	2" FNPT	1/4"	2	Yes	ME829	ME815-16LHK	MEH50/460	—
—	ME824-16	2"	2" FNPT	1/2"	2	Yes	ME829	ME815-16LHK		
—	ME828-16	2"	3-1/4" M. Acme	1/4"	2	Yes	ME829	ME815-16LHK	MEH225 MEH225SS MEH25/450	MEJ400 MEJ400SC MEJ402S
ME815-2F	ME825-2F	2"-300LB	2"-300LB	1/4"	2	Yes	ME829	ME815-16LHK		
ME815-24	ME825-24	3"	3" FNPT	1/4"	2	Yes	included	—		
ME815-3F		3"-300LB	3"-300LB	1/4"	2	Yes	included	—		

To order Teflon® or Viton® Seal add "T" for Teflon® and "V" for Viton® after the prefix part number i.e. ME815T-10 or ME815V-10

Teflon® is a trademark of DuPont Company and Viton® is a trademark of DuPont Performance Elastomers.



Next Generation Globe & Angle Valves

These *Next Generation High Flow* globe and angle valves have the same great features of the original *High Flow* Marshall Excelsior globe and angle valves with additional product performance enhancements. These globe and angle valves provide a positive shutoff that is highly reliable with *High Flow* performance with bidirectional flow or reduced product emissions.

Integrated Back Check Feature (IBC) - Designed for use in sections of piping where the trapped liquid pressure may exceed 100 psig between two valves. When trapped liquid pressure exceeds 100 psig, the integrated back check feature automatically bypasses trapped downstream system pressure through the valve seat to the upstream side of the valve into the product container or piping. A closed looped system is created because the 100 psig is far below the 400—500 psig set pressure of a hydrostatic relief valve keeping the product in the system and reducing product emissions.

Warning: NFPA 58 requires that a hydrostatic relief valve be installed into any section of piping that could allow liquid to become trapped between two shutoff valves.

Integrated Pilot Feature (P) - Designed for sections of piping that have bidirectional flow. Standard globe and angle valves installed in bidirectional systems can have a potential for back pressure to build-up on the upstream side of a closed valve. This pressure adds to the force required to open the valve causing additional wear to the valve stem and seat material. The integrated pilot feature allows the first portion of stem travel to unseat the pilot orifice, automatically equalizing the system pressure prior to unseating the valve holder seal. This greatly reduces the opening torque required in bidirectional systems and prevents premature wear of the primary valve seat material and valve components.

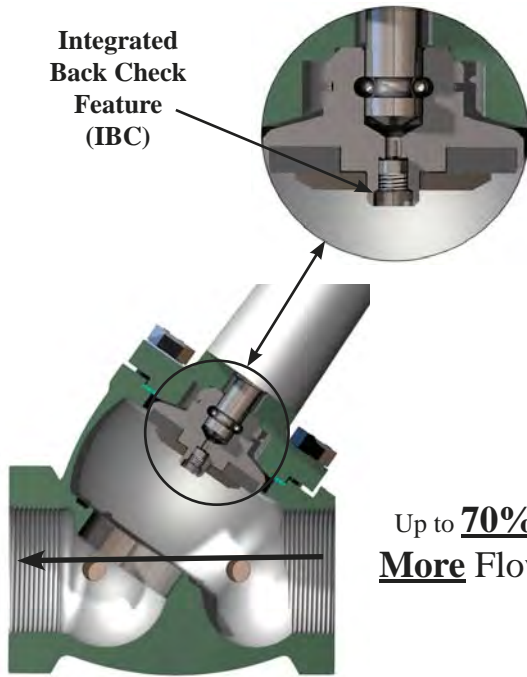

Integrated Back Check Feature (IBC)



Up to **70% More Flow**

ME825IBC-16
U.S. and Canada Patented

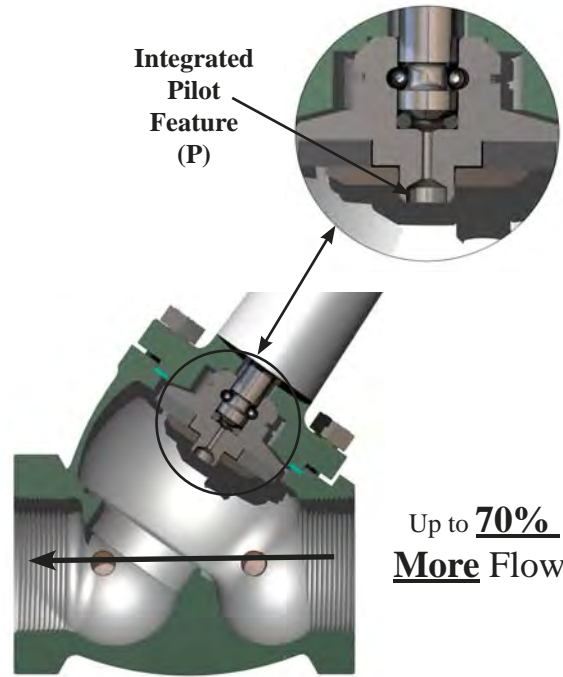

Integrated Pilot Feature (P)

Up to **70% More Flow**

ME825P-16
U.S. and Canada Patented

Part No.				Inlet (FNPT)	Outlet	Side Port (FNPT)	No. of Side Ports	Flange Style Bonnet	Accessories		
Angle		Globe							E-Z Turn Knob	Hydrostatic Relief Valves	Vent Valves
Integrated Back Check	Pilot Feature	Integrated Back Check	Pilot Feature								
ME815IBC-16	ME815P-16	ME825IBC-16	ME825P-16	2"	2" FNPT	1/4"	2	Yes	ME829	MEH225 MEH225SS MEH25/450	MEJ400 MEJ400SC MEJ402S
—	—	ME828IBC-16	ME828P-16	2"	3-1/4" Male Acme	1/4"	2	Yes	ME829		
—	—	ME824IBC-16	ME824P-16	2"	2" FNPT	1/2"	2	Yes	ME829	MEH50/460	—

Next Generation 2" Bottom Port Globe Valves

Provides a positive shut-off valve that is highly reliable with *High Flow* performance while providing bi-directional flow. Ideally suited for use on transport trailers with 1/2" blow down lines to provide rapid and complete product evacuation prior to disconnecting the transfer hose. Valves can be purchased with hydrostatic relief valves pre-installed in the side port of the globe valve downstream of the main seal.

- All of the same great features of the original full flow MEC globe valves with additional product performance enhancements.
- **Pilot Feature: (P)** These globe valve models incorporate a pilot orifice feature to facilitate pressure equalization in sections of system piping that have bidirectional flow or high differential pressures. This greatly reduces the opening torque required and prevents premature wear of the valve seat.

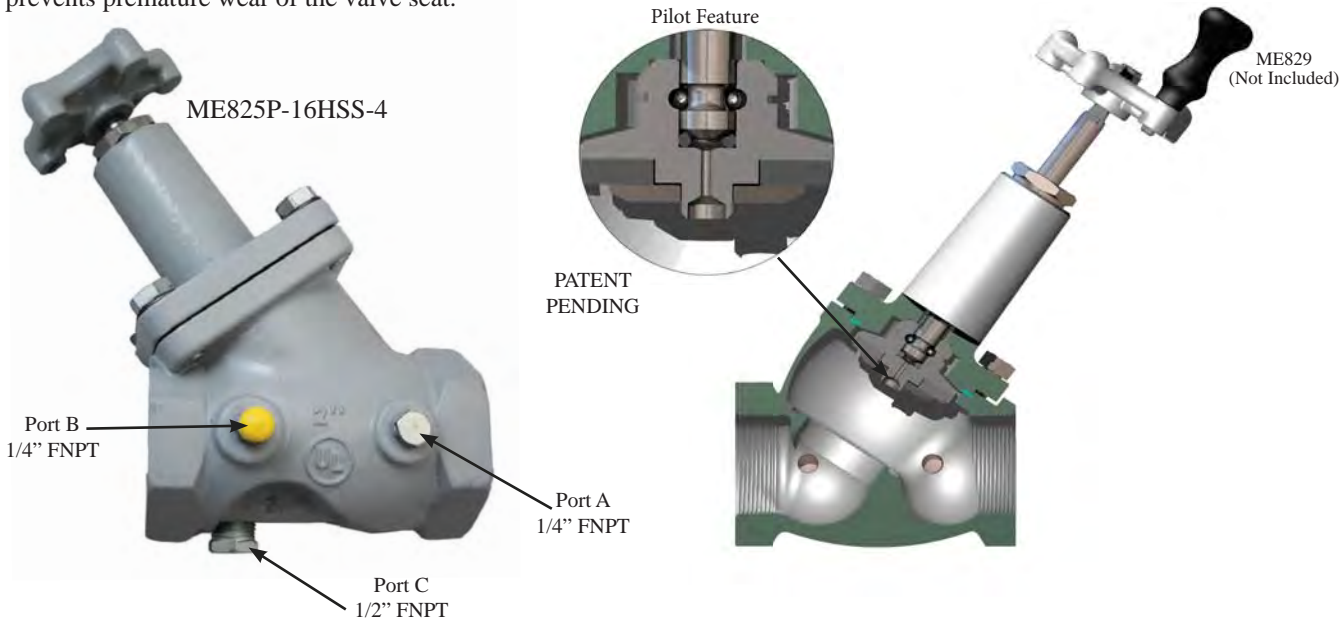

Next Generation Globe and Angle Valves							Accessories
Part No.	Description	1/4" FNPT Side Port A	1/4" FNPT Side Port B	1/2" FNPT Bottom Port	Inlet/Outlet		E-Z Turn Knob
ME825P-16-4	Full Flow Valve with Integrated Pilot Feature	Plugged	Plugged	Plugged	2" FNPT		ME829
ME825P-16H-4	Full Flow Valve with Integrated Pilot Feature	Plugged	MEH225	Plugged	2" FNPT		ME829
ME825P-16HSS-4	Full Flow Valve with Integrated Pilot Feature	Plugged	MEH225SS	Plugged	2" FNPT		ME829

Push-To-Turn Locking Handwheel Kit

Helps prevent accidental opening of any 1-1/4", 1-1/2", or 2" MEC angle or globe valve configuration. Once installed the kit requires the operator to push down on the hand wheel to engage the valve stem in order to open or fully close the valve making it a deliberate action to actuate. The ejection spring disengages the handwheel from the stem when released, preventing unintentional opening of the valve.

Part No.	Description
ME815-16LHK	Push-To-Turn Locking Handwheel Kit for all 1-1/4", 1-1/2" & 2" MEC Angle / Globe Valves
Note: MEC strongly recommends use of ME829 EZ-Turn Handwheel knob to promote ease of use for this product (NOT INCLUDED IN ME815-16LHK KIT).	



Full Port Flanged Globe Valves

The Full Port Flanged Globe Valves provide all the servicability features of a traditional globe valve with the full port flow capacity of a ball valve. Flanged end connections facilitate easy servicing along with a replaceable valve seat providing long service life for your investment. The valve also features an integrated pilot feature allowing pressure equalizing across the valve seat for bi-directional system flow.

Full Port Flanged Globe Valve Features

- Has same great reliable and durable teflon stem packing glands as our other globe valves
- Features exclusive slip cam construction for full port flow rates
- All stainless steel internal component construction for maximum corrosion resistance
- Removable bonded main seat disc assembly
- Same overall length as ANSI ball valve
- Pilot Feature: These globe valve models incorporate a pilot orifice feature to facilitate pressure equalization in sections of system piping that have bidirectional flow or high differential pressures. This greatly reduces the opening torque required and prevents premature wear of the valve seat.



ME825-3F

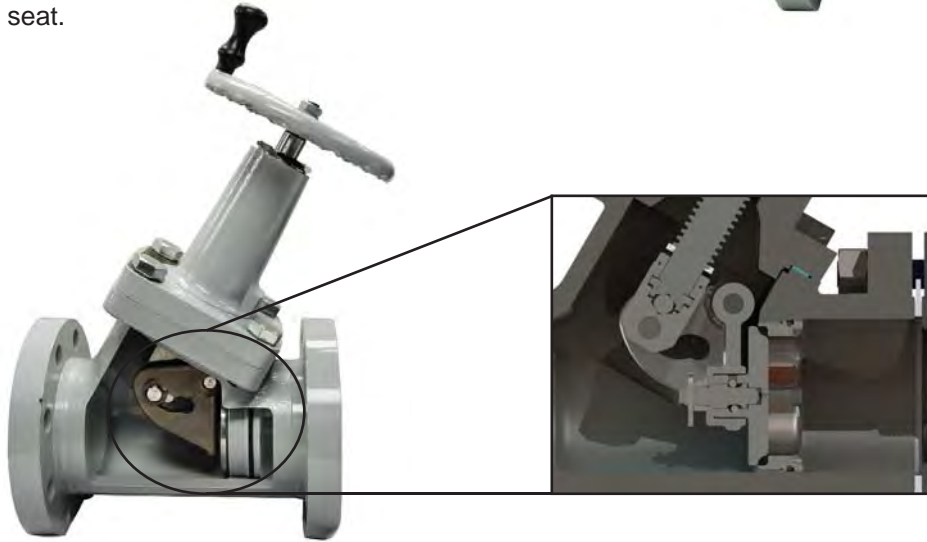

Part No.	Description	Side Port	No. of Side Ports	Inlet	Outlet
ME825-3F	Full Port Globe Valve with Integrated Pilot Feature	1/4" FNPT	2	3"-300 LB	3"-300 LB
ME825-4F	Full Port Globe Valve with Integrated Pilot Feature	1/4" FNPT	2	4"-300 LB	4"-300 LB
Accessories					
Part No.	Description				
ME829	Black Handwheel E-Z Turn Knob Kit				
ME980SK-24	3" & 4"-300LB ESV & Globe Valve Flange Stud Kit				
ME904S-3F-027	3"-300 LB Spiral Ring Flange Gasket-Carbon Steel				
ME904S-4F-027	4"-300 LB Spiral Ring Flange Gasket-Carbon Steel				

High Flow Bypass Valves For Bobtail Truck/ Plant Applications

These bypass valves are specifically designed to protect truck and plant pumps from damage due to excessive pressure while providing the industry's best bypass flow rates across a full range of set pressures. They feature wide open flow channels with an orifice weep hole chamber to prevent the valve from slamming open / closed. The weep hole chamber also helps prevent valve seat chatter by allowing constant pressure communication between both the upstream and downstream side of the seat.



Part No.	Description	Standard Spring Range*
ME840-10-125	1-1/4" FNPT High Flow Bypass Valve	90-125 PSI
ME841-10-125	1-1/4" Socket Weld High Flow Bypass Valve	90-125 PSI
ME840-12-125	1-1/2" FNPT High Flow Bypass Valve	90-125 PSI
ME841-12-125	1-1/2" Socket Weld High Flow Bypass Valve	90-125 PSI
ME840-16-125	2" FNPT High Flow Bypass Valve	90-125 PSI
ME840C-16-125	2" FNPT Classic Flow Bypass Valve	90-125 PSI
ME841-16-125	2" Socket Weld High Flow Bypass Valve	90-125 PSI
ME840-125	1-1/4" -2" Universal High Flow Bypass w/o Flanges	90-125 PSI

*Alternate spring ranges available. Please see replacement parts section in back of catalog.

Universal Flange Kits	
Part No.	Description
ME840-10F	1-1/4" FNPT 4 Bolt Flange Adapter Plate w/ Bolts & O-Ring
ME841-10F	1-1/4" Socket Weld 4 Bolt Flange Adapter Plate w/ Bolts & O-Ring
ME840-12F	1-1/2" FNPT 4 Bolt Flange Adapter Plate w/ Bolts & O-Ring
ME841-12F	1-1/2" Socket Weld 4 Bolt Flange Adapter Plate w/ Bolts & O-Ring
ME840-16F	2" FNPT 4 Bolt Flange Adapter Plate w/ Bolts & O-Ring
ME841-16F	2" Socket Weld 4 Bolt Flange Adapter Plate w/ Bolts & O-Ring
MEP840-10	1-1/4" FNPT 4 Bolt 90° Flange Adapter Elbow w/ Bolts & O-Ring
MEP841-10	1-1/4" Socket Weld 4 Bolt 90° Flange Adapter Elbow w/ Bolts & O-Ring
MEP840-12	1-1/2" FNPT 4 Bolt 90° Flange Adapter Elbow w/ Bolts & O-Ring
MEP841-12	1-1/2" Socket Weld 4 Bolt 90° Flange Adapter Elbow w/ Bolts & O-Ring
MEP840-16	2" FNPT 4 Bolt 90° Flange Adapter Elbow w/ Bolts & O-Ring
MEP841-16	2" Socket Weld 4 Bolt 90° Flange Adapter Elbow w/ Bolts & O-Ring

High Flow Bypass Valve Features

- All ductile iron body and bonnet
- All stainless steel wetted components
- Heavy duty protective stem cap
- Wide open flow channels for industry best flow rates
- Orifice weep hole to maintain constant pressure above and below valve seat
- Large range of set pressure springs
- Weldable steel NPT and socket weld flanges
- Zinc dichromate finish for maximum corrosion resistance
- Available with or without flanges factory assembled
- Flanges available 1-1/4" through 2" NPT and socket weld construction
- Universal 4 bolt, flanged body configuration
- Two 1/4" FNPT plugged auxiliary pressure ports
- Factory set at 125 PSI



ME840C-16-104
Classic Poppet
*Designed to create higher differential pressure and increased poppet travel in low flow applications such as bobtails



High Flow Bypass Valves for Dispensing Applications

Intended for use in small cylinder filling applications as a bypass and primer valve for turbine style dispensing pumps. These bypass valves feature a special “check ball” mechanism that helps eliminate vapor from liquid while keeping the pump flooded and properly primed. The priming and vapor elimination features in combination with the high flow bypass design significantly reduces pump wear and promotes seal longevity.

High Flow Bypass Valve Features

- Ductile iron body and bonnet construction
- Large range of set pressure springs
- Two 1/4" FNPT plugged auxiliary pressure ports (outlet side)
- Stainless steel main valve poppet
- Heavy duty protective stem cap
- Available in 3/4" & 1" FNPT threaded versions
- Factory set at 125 PSI
- Durable powder coat finish



ME840-6/150

Part No.	Description	Standard Spring Range*
ME840-6-150	3/4" FNPT High Flow Bypass Valve	50-150 PSI
ME840-8-150	1" FNPT High Flow Bypass Valve	50-150 PSI

* Alternate spring ranges available. Please see replacement parts section in back of catalog

High Flow 3" Bypass Valve for Plant Applications

Specifically designed for plant systems where maximum bypass flow is necessary to protect the pump from rapid pressure changes or over pressurization. Perfectly suited for 4" base mount pumps or larger pump applications.

3" High Flow Bypass Valve Features

- Ductile iron body and bonnet construction
- All stainless steel internal wetted components
- Bonnet / seat positioned at 35° angle for maximum product flow
- Downstream bleed port to boost product flow during bypass
- Two 1/4" FNTP plugged auxiliary pressure ports
- Heavy duty protective stem cap
- Factory set at 100 PSI
- Durable powder coat finish



ME840-24/100

Part No.	Description	Standard Spring Range*
ME840-24-100	3" FNPT High Flow Bypass Valve	0-100 PSI

* Alternate spring ranges available. Please see replacement parts section in back of catalog

4 Bolt Flange Unions

These 4 bolt unions can be used anywhere system piping needs to be joined together between shut off valves. Use of piping unions such as these significantly improves the ease by which maintenance can be performed particularly where long runs or multiple directional changes are necessary. Our flange unions feature a captured o-ring design, hardened mounting bolts, and are available in NTP or Socket Weld configurations. Suitable for use in mobile or stationary applications.

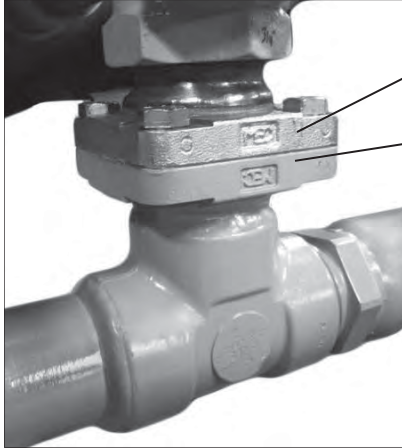

ME841-16F

(Requires purchase of flat face flange)

ME843-16-107

(Requires purchase of mating universal flange kit)

MEC 4 Bolt Flange Union Features

- All steel construction for maximum durability and weldability
- Available in 1-1/4" - 2" FNPT or Socket Weld configurations
- Zinc Plated for maximum corrosion resistance
- Approved for use in LPG or NH₃ service
- Rated 400 WOG

MEC Flat Face Flanges	
Part No.	Description
ME842-10-107	1-1/4" FNPT Tapped 4 Bolt Flat Face Flange Adapter
ME843-10-107	1-1/4" Socket Weld 4 Bolt Flat Face Flange Adapter
ME842-12-107	1-1/2" FNPT Tapped 4 Bolt Flat Face Flange Adapter
ME843-12-107	1-1/2" Socket Weld 4 Bolt Flat Face Flange Adapter
ME842-16-107	2" FNPT Tapped 4 Bolt Flat Face Flange Adapter
ME843-16-107	2" Socket Weld 4 Bolt Flat Face Flange Adapter
MEC Universal Flange Kit	
Part No.	Description
ME840-10F	1-1/4" FNPT 4 Bolt Flange Adapter Plate w/ Bolts & O-Ring
ME841-10F	1-1/4" Socket Weld 4 Bolt Flange Adapter Plate w/ Bolts & O-Ring
MEP840-10	1-1/4" FNPT 4 Bolt 90° Flange Adapter Elbow w/ Bolts & O-Ring
MEP841-10	1-1/4" Socket Weld 4 Bolt 90° Flange Adapter Elbow w/ Bolts & O-Ring
ME840-12F	1-1/2" FNPT 4 Bolt Flange Adapter Plate w/ Bolts & O-Ring
ME841-12F	1-1/2" Socket Weld 4 Bolt Flange Adapter Plate w/ Bolts & O-Ring
MEP840-12	1-1/2" FNPT 4 Bolt 90° Flange Adapter Elbow w/ Bolts & O-Ring
MEP841-12	1-1/2" Socket Weld 4 Bolt 90° Flange Adapter Elbow w/ Bolts & O-Ring
ME840-16F	2" FNPT 4 Bolt Flange Adapter Plate w/ Bolts & O-Ring
ME841-16F	2" Socket Weld 4 Bolt Flange Adapter Plate w/ Bolts & O-Ring
MEP840-16	2" FNPT 4 Bolt 90° Flange Adapter Elbow w/ Bolts & O-Ring
MEP841-16	2" Socket Weld 4 Bolt 90° Flange Adapter Elbow w/ Bolts & O-Ring



High Flow Low Emission Hose End Valves

These hose end valves are leading the industry in minimal product loss during disconnect without sacrificing flow. They have instant full-on flow with the added protection of a quick closing, self-locking handle to prevent accidental opening of the valve during transport. They are designed to be used at the end of a filling hose on a bobtail, dispensing system or nurse tank.

Hose End Valve Features

- All stainless steel component construction
- Molded and riveted on valve main seal
- Vents less than .50cc for minimal loss of product at disconnect
- Self-locking toggle handle prevents accidental valve opening
- Toggle handle and stem assembly rotate 360°
- Durable ductile iron valve body with automotive grade powder coat finish
- Stainless steel 1-3/4" female Acme insert cast into the handle
- No additional adapters or connectors needed for operation
- Optional extended version offers 6 inches of additional reach for filling underground containers or other hard to reach applications
- Optional composite style offers a durable lightweight handle that is resistant to frosting and cold transfer during the filling operation
- Optional factory installed **EZTurn** stainless steel swivel



Part No.	Inlet (FNPT)	Outlet (F. Acme)	Handle Style	Handle Material	Factory Installed E-Z Turn Swivel	Extended Version	Accessories
							Holster
ME800	1"	1-3/4"	Standard	Aluminum	No	No	MEP801
ME800WS	1"	1-3/4"	Standard	Aluminum	Yes	No	MEP801
ME800C	1"	1-3/4"	Standard	Composite	No	No	MEP801
ME800CWS	1"	1-3/4"	Standard	Composite	Yes	No	MEP801
ME800G	1"	1-3/4"	Fluted	Aluminum	No	No	MEP801
ME800GWS	1"	1-3/4"	Fluted	Aluminum	Yes	No	MEP801
ME800GC	1"	1-3/4"	Fluted	Composite	No	No	MEP801
ME800GCWS	1"	1-3/4"	Fluted	Composite	Yes	No	MEP801
ME800EXT	1"	1-3/4"	Standard	Aluminum	No	Yes	No
ME800EXTWS	1"	1-3/4"	Standard	Aluminum	Yes	Yes	No



Hose End Valve Lock

Designed to prevent valve operation while in place, eliminating the possibility of accidental discharge and/or theft of product. Simply slide the lock over the handle/bonnet of the hose end or quick acting dispensing valve. For maximum security a common padlock can be installed.

Hose End Valve Lock Features

- All stainless steel construction
- 3/8" diameter through holes for standard 2-1/2" shackle style padlock

Part No.	Fits	Accessories	
		2-1/2" Deep Shackle Padlock	
		Keyed Alike	Keyed Different
ME540	ME800, ME810, ME820 Series	ME540P-KA	ME540P-KD



Padlock Sold Separately

ME800G Not Included

Hose End Valve Holster

Designed to provide a durable and convenient receptacle to store bobtail hose end delivery valves during over-the-road transit. This holster can be mounted fully above deck or partially below deck in left or right hand hose reel applications with an ergonomic angle providing optimum conditions for delivery personnel.

Hose End Valve Holster Features

- All aluminum and stainless steel construction
- Urethane anti-vibration valve sleeve to prevent incidental damage to delivery valve
- Machined adjustment ribs for easy, secure height adjustment
- Deck backing plate and all mounting hardware supplied



MEP801



MEP801H

U.S and Canada Patented

Part No.	Description	Fits	Accessories
MEP801	Bobtail Hose End Valve Holster-Aluminum	ME800 Series	MEP801H (Urethane Weather Hood)
MEP802	Bobtail Hose End Valve Holster-Aluminum w/ All Weather Hood	ME800 Series	MEP801-04 (Urethane Holster Strap)



Hose End Swivel Connectors

The **EZTurn** hose end swivel connector allows the hose end valve to rotate 360° creating an easier connection to the tank filler valve while under pressure. It also promotes hose life by preventing twisting and kinking during reeling and unreeling from hose reel.



EZTurn Hose End Swivel Connector Features

- All stainless steel construction for maximum durability and corrosion resistance
- Large bearing surface for increased strength and durability
- 360° rotation under maximum working pressure of 400 psig
- Our  LISTED seal pack design allows for extremely long life with no maintenance required
- Straight through bore for unobstructed flow characteristics
- See low emission hose end valves for factory installed **EZTurn**

Part No.	Inlet (FNPT)	Outlet (MNPT)
ME850SS-6	3/4"	3/4"
ME850SS-6/8	3/4"	1"
ME850SS-8	1"	1"
ME850SS-8/6	1"	3/4"

Grounding Stud



Designed to help prevent static electricity from being generated due to friction from the pump. In some cases static electricity can build-up enough to create an ignition source and cause an explosion.

Part No.	Thread
ME4H	3/8"-16

Smart Interlock Technology

Designed to prevent a vehicle from being operated while the hose end delivery valve, loading line or wheel chocks are in use. The smart interlock technology connects directly to the Allison Automatic Transmission through the "Auxiliary Function Range Inhibit" or braking system for manual transmission vehicles. This revolutionary system incorporates the industry's best and most durable sensor, TURCK - which is backed with a lifetime product warranty.

Smart Interlock Technology Features

- "Potted" TURCK proximity switch for maximum weather resistance and security against vibration
- Supplied with water tight conduit and necessary wiring hardware to reach 5' below deck with water tight receptacle plug

Sensor Bracket Assembly Features

- Smart interlock technology
- Molded urethane sensor body housing for durability and maximum sensor protection
- Stainless steel all weather mounting band and hardware

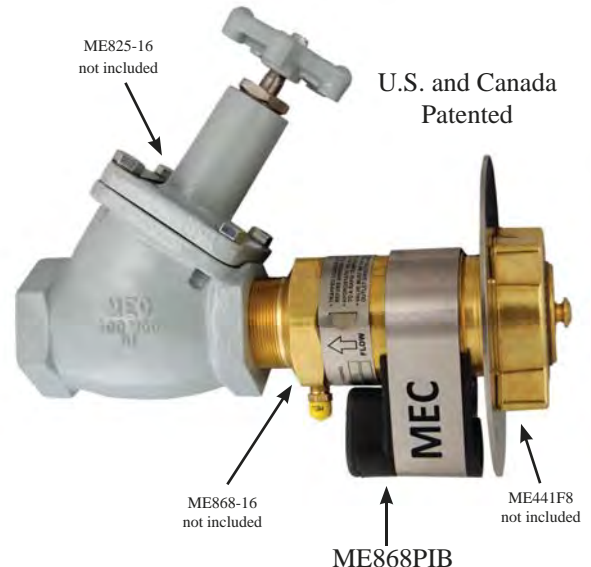

Smart Interlock Technology

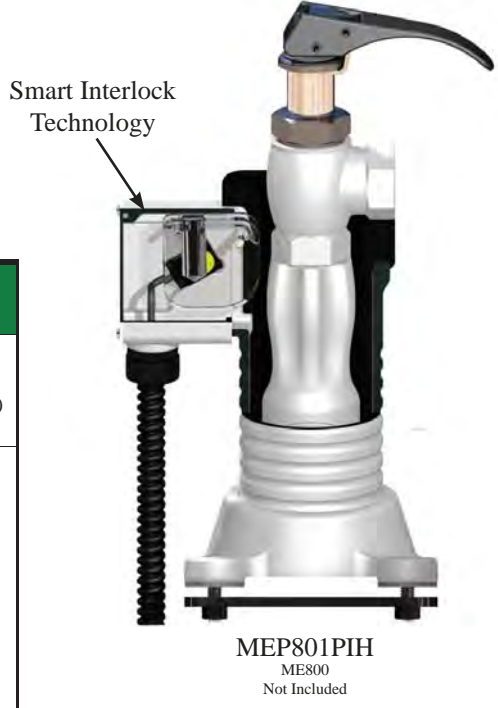

Part No.	Description	Temperature Range	Accessories
ME200PIB	Sensor Bracket Assembly for ME200 Wheel Chocks	-20° to +160° F.	ME200EXT (Standoff Extension Kit)
ME200PIBK	Sensor Bracket Assembly with ME200 Wheel Chocks	-20° to +160° F.	
ME217PIB	Sensor Bracket Assembly for ME217 Series	-20° to +160° F.	MEP801PC/20 (20' Proximity Cable) MEP801PC/30 (30' Proximity Cable) Includes Water Tight Receptacle Plug
ME503PIB	Sensor Bracket Assembly for ME503-16 & ME252-16	-20° to +160° F.	
ME807PIB	Sensor Bracket Assembly for ME807 Series	-20° to +160° F.	
ME868PIB	Sensor Bracket Assembly for ME868 Valve Series	-20° to +160° F.	
MEP801PIH	Sensor Assembly with MEP801 Hose End Valve Holster	-20° to +160° F.	
MEP802PIH	Holster W/Proximity Interlock Sensor Assembly with All Weather Hood	-20° to +160° F.	
MEP801PIK	Interlock Retro Fit Kit for MEP801 Hose End Valve Holster	-20° to +160° F.	
MEP801PIKL	Low Temperature Interlock Retro Fit Kit for MEP801 Hose End Valve Holster	-50° to +160° F.	
ME890PIB	Universal Sensor Bracket Assembly for Enclosures	-20° to +160° F.	



Smart Interlock Technology Wiring Harness Kits						
Part No.	Description	No. of Relays	LED Power Indicator	Inline Fuse	Cable Length	Accessories
MEP801PCK/20	Wiring Harness Kit	1	Yes	Yes	20'	MEP801PC/20 (20' Proximity Cable)
MEP801PCK/30	Wiring Harness Kit	1	Yes	Yes	30'	
MEP802PCK/20	Wiring Harness Kit	2	Yes	Yes	20'	MEP801PC/30 (30' Proximity Cable)
MEP802PCK/30	Wiring Harness Kit	2	Yes	Yes	30'	
MEP803PCK/30	Wiring Harness Kit	3	Yes	Yes	30'	Includes Water Tight Receptacle Plug



Quick Acting Dispensing Valves

Dispensing valves are designed to be used at the end of a filling hose for bobtail, dispensing system or nurse tank filling operations. These valves have instant full-on flow with the added protection of a quick closing, self-locking handle to prevent accidental opening of the valve during transport.



ME810 Series



ME820 Series



Quick Acting Dispensing Valve Features

- All stainless steel internal components
- Self-locking toggle handle prevents accidental operation
- Durable ductile iron valve body with automotive grade powder coat finish
- Toggle handle and stem assembly rotate 360°
- Stainless steel factory installed vent valve

Part No.		Inlet & Outlet (FNPT)	No. of Side Ports	Accessories		
Angle	Globe			MNPT x 1-3/4 F. Acme Adapter		
				Short Brass	Short Steel*	Extended Steel*
ME810-4	ME820-4	1/2"	1	ME110 ME110C	—	ME635-4 ME635G-4
ME810-6	ME820-6	3/4"	1	ME111 ME111C	ME111S ME111SC	ME635-6 ME635G-6
ME810-8	ME820-8	1"	1	ME112 ME112C	ME112S ME112SC	ME635-8 ME635G-8

* Rated for LP-Gas & NH₃



ME821 Series



Part No.	Body Style	Inlet & Outlet (FNPT)	No. of Side Ports	Accessories		
				MNPT x 1-3/4 F. Acme Adapter		
				Short Brass	Short Steel*	Extended Steel*
ME821-4	Globe	1/2"	2	ME110 ME110C	—	ME635-4 ME635G-4
ME821-6	Globe	3/4"	2	ME111 ME111C	ME111S ME111SC	ME635-6 ME635G-6
ME821B-4**	Globe	1/2"	2	ME110 ME110C	—	ME635-4 ME635G-4
ME821B-6**	Globe	3/4"	2	ME111 ME111C	ME111S ME111SC	ME635-6 ME635G-6

* Rated for LP-Gas & NH₃
** Includes MEJ400 Brass Vent Valve

Economy Quick Acting Dispensing Valve Features

- All stainless steel internal components
- Reduced size and weight for easier handling
- Self-locking toggle handle prevents accidental operation
- Durable ductile iron valve body with automotive grade powder coat finish
- Toggle handle and stem assembly rotate 360°
- Factory installed 1/4" FNPT plugged ports

Hose End Fill Check Adapters

These adapters are intended to be attached to the LP-Gas delivery truck hose outlets. They feature minimal flow restriction which allows for fast delivery while providing an integral check valve to prevent further product loss if the tank fill valve fails to close. In the event the tank fill valve should fail, leave the fill adapter connected to the fill valve and disconnect the filler hose end valve. Then place the filler valve cap onto the fill adapter. The tank fill valve should be repaired immediately.

To increase flow up to 30 percent over standard hose end filler adapters use the ME578 hose end fill adapter. It is a full-flow, manually operated hose end fill adapter where the user controls whether the valve is open or closed, providing maximum protection against product discharge.

Hose End Fill Adapter Features

- Integral breakaway feature in the event of truck roll away leaving check intact on tank
- ME570, ME572, ME574, ME578 shortest overall height in the industry allowing adapters to fit inside tank hood
- ME571 has a floating internal seat design which allows check to swivel freely when installed on hose end valve
- ME571H has same features as standard ME571 but with 30% MORE FLOW
- ME578 has a full-port design which allows for full flow
 - Removable shutoff key and key ring supplied
- Extended versions provide an additional 7" for use on underground tanks
 - Prevents pinching or cutting of the delivery hose on the protective tank collar
 - Eliminates dangerous extensions that do not incorporate the appropriate fill check device
 - Eliminates unsafe stacking of multiple fill check adapters to obtain the desirable fill connection height
 - Overall length allows adapter to fit inside protective tank collar
 - Optional heavy duty aluminum handle with a stainless steel 1-3/4" female Acme insert cast into the handle



ME570



ME572



ME571



ME571H



ME578



ME574



ME574EXT



ME572EXTHD

Part No.	Filler Valve F. Acme Connection	Hose End M. Acme Connection	Handle Style	Handle Material	Swivels	Factory Installed Vent Valve	Extended Version	Additional Keys
ME570	1-3/4"	1-3/4"	Standard	Brass	No	No	No	—
ME571	1-3/4"	1-3/4"	Standard	Brass	Yes*	No	No	—
ME571H	1-3/4"	1-3/4"	Standard	Brass	Yes*	No	No	—
ME572	1-3/4"	1-3/4"	Standard	Brass	Yes	No	No	—
ME572EXT	1-3/4"	1-3/4"	Standard	Brass	Yes	No	Yes	—
ME572EXTHD	1-3/4"	1-3/4"	Heavy Duty	Cast Aluminum	Yes	No	Yes	—
ME574	1-3/4"	1-3/4"	Standard	Brass	Yes	Yes	No	—
ME574EXT	1-3/4"	1-3/4"	Standard	Brass	Yes	Yes	Yes	—
ME574EXTHD	1-3/4"	1-3/4"	Heavy Duty	Cast Aluminum	Yes	Yes	Yes	—
ME578	1-3/4"	1-3/4"	Standard	Brass	Yes	No	No	ME578-02
ME578C	1-3/4"	1-3/4"	Heavy Duty	Brass	Yes	No	No	ME578-02

* ME571 and ME571H allows the hose end valve to swivel while connected to the filler hose end adapter



Excess Flow Warning

An excess flow valve is a protective device to help control the discharge of product in the event of complete breakage of pipe lines or hose rupture. However, an excess flow valve can only offer limited protection from gas discharge, because it will only close under those conditions which cause the flow through the valve to exceed its rated closing flow, and even when closed it necessarily allows some “bleed” past the valve.

Excess flow check valves have helped minimize gas loss in many incidents involving breakage of hoses and transfer piping. Thus, they do provide a useful safety function in LP-Gas systems. However, there have also been transfer system accidents where excess flow valves have been ineffective in controlling gas loss due to a variety of conditions and to the inherent limitations of these valves. This bulletin explains the protection excess flow valves can offer, points out conditions which can interfere with that protection, and offers suggestions for effective excess flow valve installation.

If any of the following conditions are present, an excess flow valve is not designed to close and may not provide protection:

1. The piping system restrictions (due to pipe length, branches, reduction in pipe size, or number of other valves) decrease the flow rate to less than the valve’s closing flow. (Valve should be selected by closing flow rating—not just by pipe size).
2. The break or damage to the downstream line is not large enough to allow enough flow to close the valve.
3. A shutoff valve in the line is only partially open and will not allow enough flow to close the excess flow valve.
4. LP-Gas pressure upstream of the excess flow valve, particularly due to low temperature, is not high enough to produce a closing flow rate.
5. Foreign matter is lodged in the valve and prevents closing.
6. A build-up of process material, which may be found in LP-Gas, may occur over a period of time causing the valve to stick open and prevent proper operation.
7. The piping break or damage occurs upstream of an in-line excess flow valve, so the escaping product is not passing through the valve.
8. The flow through the valve is in the wrong direction. (Excess flow valves only respond to flow in one direction.)
9. The excess flow valve has been damaged, or is otherwise not in operating condition.

Excess flow valves have numerous conditions where the valve may not operate correctly and should not be the sole means in the event a pipe is damaged and product needs to be controlled. It is recommended that another shutoff protection device be installed in addition to or instead of an excess flow valve to control the escape of product when a pipe is damaged.

Where excess flow valves are installed,, they should be checked to see that:

1. They are installed in the correct direction—the arrow on the valve indicates the shutoff direction. (Excess flow valves only respond to flow in one direction.)
2. The flow rating on the valve is proper for the installation. The rating must be above the normal system flow, but no higher than necessary, to prevent “nuisance” closing in normal conditions. If the manufacturer’s catalog information is not sufficient, the valve suppliers can provide sizing assistance.
3. To help avoid separating the upstream piping and valve, an in-line excess flow valve is installed to help pipe damage occur downstream.

When the excess flow valves can be examined separate from the line (before the installation or if removed for system maintenance), they should be checked to see that the parts are in good condition and that the poppet can be pushed fully closed.

Testing of Excess Flow Valves

In order to test an excess flow valve in a piping system, the flow through the valve must exceed the valve’s closing rating. This test should only be attempted by trained personnel familiar with the process. If no one at the facility has experience in proper testing, outside expert help should be obtained. The exact procedure used may vary with the installation, gas discharge exposure, and availability of equipment.

In general, most testing makes use of the fact that excess flow valves are “surge sensitive” and will close quicker under a sudden flow surge than under steady flow. A sufficient surge can often be created by using a quick closing valve to control sudden, momentary flow into a tank or piping section containing very low pressure. An audible click from the excess flow valve (and corresponding stoppage of flow) indicates its closure.

A test involving venting gas to the atmosphere is hazardous and may be impractical or illegal.

Any test of any excess flow valve will not prove that the valve will close in an emergency situation, due to reasons cited before. This test will only check the valve’s condition, and the flow rate sizing for those test conditions.

For additional information on excess flow valves contact your local distributor, Marshall Excelsior and refer to NFPA 58.

Excess Flow Valves

Marshall Excelsior offers the Largest Closing Flow Selection in the industry. These excess flow valves are intended for use in liquid or vapor LP-Gas or NH₃ systems. These valves can be used for filling, withdrawal and vapor equalization in containers or line applications, specifically long lines or branch piping. This product is designed to protect against excessive discharge as a result of a break in the hose or piping system. The excess flow feature is designed to remain closed after activation until the system pressure equalizes on both sides of the shutoff poppet.

Warning: An excess flow valve will not activate if there is a break or leak downstream of the valve that does not equal or exceed the closing flow of the valve or if the excess flow valve installed exceeds the flow capacity of the system. See the Excess Flow Warning page for more information regarding the use of excess flow devices.

Excess Flow Valve Features

- Integral breakaway feature leaves valve assembly intact with internal hex broach for easy removal
- All stainless steel internal components

Part No.			Inlet MNPT	Outlet FNPT	Closing Flow GPM Propane
Brass	Steel*	Stainless Steel*			
ME880-4/1.8	—	—	1/4"	1/4"	1.8
ME880-6/4.6	ME880S-6/4.6	ME880SS-6/4.6	3/4"	3/4"	4.6
ME880-6/14	ME880S-6/14	ME880SS-6/14	3/4"	3/4"	14
ME880-6/17	ME880S-6/17	ME880SS-6/17	3/4"	3/4"	17
ME880-6/22	ME880S-6/22	ME880SS-6/22	3/4"	3/4"	22
ME880-6/28	ME880S-6/28	ME880SS-6/28	3/4"	3/4"	28
ME880-10/32	ME880S-10/32	ME880SS-10/32	1-1/4"	1-1/4"	32
ME880-10/42	ME880S-10/42	ME880SS-10/42	1-1/4"	1-1/4"	42
ME880-16/80	ME880S-16/80	ME880SS-16/80	2"	2"	80
ME880-16/105	ME880S-16/105	ME880SS-16/105	2"	2"	105
ME880-16/114	ME880S-16/114	ME880SS-16/114	2"	2"	114
—	ME882S-16/80	—	2"	2" MNPT	80
—	ME882S-16/105	—	2"	2" MNPT	105
—	ME882S-16/114	—	2"	2" MNPT	114
—	ME880S-24/265	—	3"	3"	265
—	ME880S-24/350	—	3"	3"	350
—	ME882S-24/265	—	3"	3" MNPT/2" FNPT	265
—	ME882S-24/350	—	3"	3" MNPT/2" FNPT	350

Liquid Butane Capacity = Flow Rate x .94

Liquid Anhydrous Ammonia Capacity = Flow Rate x .90



High Flow Back Check Valves

These back check flow valves lead the industry with up to **20% More Flow** than the nearest competitor. Back check valves provide flow protection to container openings or liquid lines where flow is intended for one direction. The valve is normally closed until pressure activates the valve when flow is directed into piping or containers causing the back check to open. When flow stops or reverses, the check returns to the closed position.

These valves come with dual seating capabilities or an optional bonded soft seat on the three inch model. With the dual seating capabilities, the factory installed O-ring provides a leak-free, soft seat seal which enables repair and maintenance to be done on depressurized plumbing. Remove the O-ring to allow metal-to-metal seating with a minimal leak seal to restrict flow in case of a break in the line. Note: Leaving the O-ring soft seat installed on the valve will require a minimum of 15 psig pressure differential between the transfer line and container to unseat the valve and allow it to fully open.

The optional bonded soft seat on the three inch model cannot be removed for metal-to-metal seating.



High Flow Back Check Valve Features

- Up to **20% More Flow** than nearest competitor
- Maximum flow achieved by full port and increased stem travel design
- Integral breakaway feature leaves valve assembly intact with internal hex broach for easy removal
- All stainless steel internal components
- Dual purpose seat reduces inventory from 2 to 1



ME872S-16



ME870S Series
Shown with O-Ring
Removed for
Metal-to-Metal Seat

Part No.			Inlet FNPT	Outlet MNPT	Propane Flow at 10 PSIG Pressure Differential	Bonded Soft Seat
Brass	Steel*	Stainless Steel*				
ME870-6	ME870S-6	ME870SS-6	3/4"	3/4"	24	No
ME870-10	ME870S-10	ME870SS-10	1-1/4"	1-1/4"	61	No
ME870-16	ME870S-16	ME870SS-16	2"	2"	187	No
—	ME872S-16	—	2" MNPT	2"	187	No
—	ME870S-24	—	3"	3"	449	No
—	ME870SBN-24**	—	3"	3"	449	Yes
—	ME872S-24	—	2" FNPT/ 3" MNPT	3"	449	No
—	ME872SBN-24	—	2" FNPT/ 3" MNPT	3"	449	Yes

* Rated for LP-Gas & NH₃

** Use for high flow transport applications

Liquid Butane Capacity = Flow Rate x .94

Liquid Anhydrous Ammonia Capacity = Flow Rate x .90



ME870SBN-24
Shown with Bonded
Soft Seat



ME870 Series
Shown with O-Ring
Soft Seat



High Flow Double Back Check Valves

Marshall Excelsior High Flow Double Back Check Valves provide back flow protection to container openings or liquid lines where flow is intended in one direction. The valve is normally held closed until pressure activates the valve when flow is directed into piping or containers causing the double back check to open. When flow stops or reverses, both checks return to the closed position. All MEC High Flow Double Back Check Valves are supplied with the correct ACME cap and chain assembly, as well as factory installed hydrostatic relief protection.



High Flow Double Back Check Features

- Primary Seat - Creates metal to metal seating surface
- Secondary Seat - bonded nitrile soft seat for a leak free seal
- Up to **20% More Flow** than nearest competitor
- Maximum product flow achieved by full port and stem travel design
- All models feature stainless steel stem, spring and valve guide in body check assembly
- Built in hydrostatic relief valve
- For use with **LP Gas ONLY**



Part No.	Description	Propane Flow		
		Differential Pressure		
		10 PSI	25 PSI	50 PSI
ME869-10/10	Double Back Check Valve 1-1/4" MNPT x 2-1/4" M. Acme	75	116	157
ME869-10/8	Double Back Check Valve 1-1/4" MNPT x 1-3/4" M. Acme	51	85	124
ME869-16	Double Back Check Valve 2" MNPT x 3-1/4" M. Acme	195	296	416
ME869-24	Double Back Check Valve 3" MNPT x 3-1/4" M. Acme	347	519	718



Accu-Max™ Float Gauges

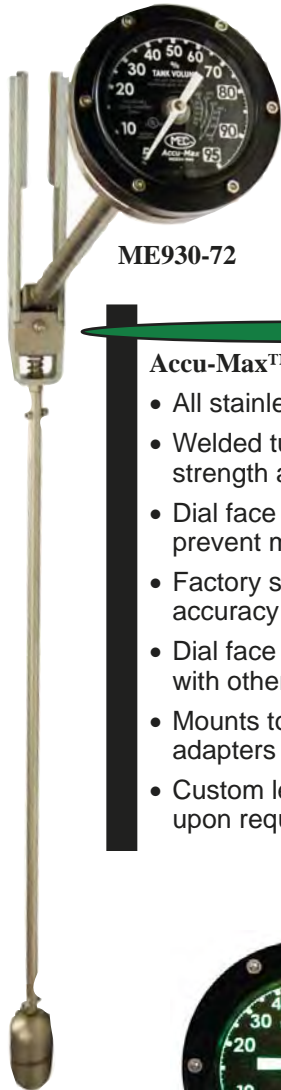

ME930-72

Designed to measure liquid levels within horizontal DOT and Stationary ASME Tanks with fluid capacities above 2,300 gallons. For maximum gauge life, the float arm features an integral spring loaded shock absorber for harsh over-the-road applications. The standard dial face features a black background for reduced glare with glow technology providing an easy to read “glow in the dark” dial face, perfect for low light situations. An optional classical style dial face is available. These gauges are suitable for use in bobtail, transport, railcar and bulk storage applications.

Note: These gauges must be installed on the centerline of the tank’s side or end for accurate readings.

Accu-Max™ Float Gauge Features

- All stainless steel construction
- Welded tube to coupling design for maximum strength and durability
- Dial face 100% sealed and argon filled to prevent moisture build-up & fogging
- Factory set and precision tuned for superb accuracy
- Dial face and mounting hardware universal with other industry standard gauges
- Mounts to all standard 8 bolt tank flange adapters
- Custom length tank configurations available upon request for 30” to 300” I.D. tank

Part No.	Type	Style	Dial Face	Dial Size	Tank Diameter
ME930-72	DOT	Standard	Glow/Black	4”	72”
ME930-79	DOT	Standard	Glow/Black	4”	79”
ME930-84	DOT	Standard	Glow/Black	4”	84”
ME930C-72	DOT	Classic	Silver/Black	4”	72”
ME930C-79	DOT	Classic	Silver/Black	4”	79”
ME930C-84	DOT	Classic	Silver/Black	4”	84”
ME940-108	ASME	Standard	Glow/Black	8”	108”
ME940-130	ASME	Standard	Glow/Black	8”	130”
ME940C-108	ASME	Classic	Silver/Black	8”	108”
ME940C-130	ASME	Classic	Silver/Black	8”	130”

Accu-Max™ Limited Warranty: Marshall Excelsior warrants Accu-Max™ float gauges and repair kits to the original buyer to be free of defects in material and workmanship under normal service and use for two years from manufactured date.

U.S. and Canada
Patented



“Glow” Technology
Standard Dial



ME940 ASME Series
Standard “Glow” Dial



ME930 DOT Series
Classic Dial



Float Gauge Accessories

Designed for mounting float gauges in DOT or ASME tanks. These zinc plated steel 8 bolt mounting flanges feature 1/2”-13 threads for easy installation.

Part No.	Connection	Connection
ME931	2-1/2” MNPT	1/2”-13 Female
ME932*	Weld	1/2”-13 Female

*Weld flanges supplied with material certification



ME931



ME932



Accu-Max Float Gauges Trans-Max Series

Measure liquid levels within horizontal DOT and Stationary ASME Tanks with 1" FNPT tank gauge port openings. Designed to replace rotary style gauges in tanks with fluid capacities greater than 2,300 gallons. Suitable for use in bobtail, transport, and bulk storage applications. MEC exclusive "wedge" design allows for easy installation while greatly reducing time spent inside the vessel.

Note: The heavy duty design of this gauge requires entering vessel through man-way during installation.



**ME930WG DOT Series
ME940WG ASME Series**

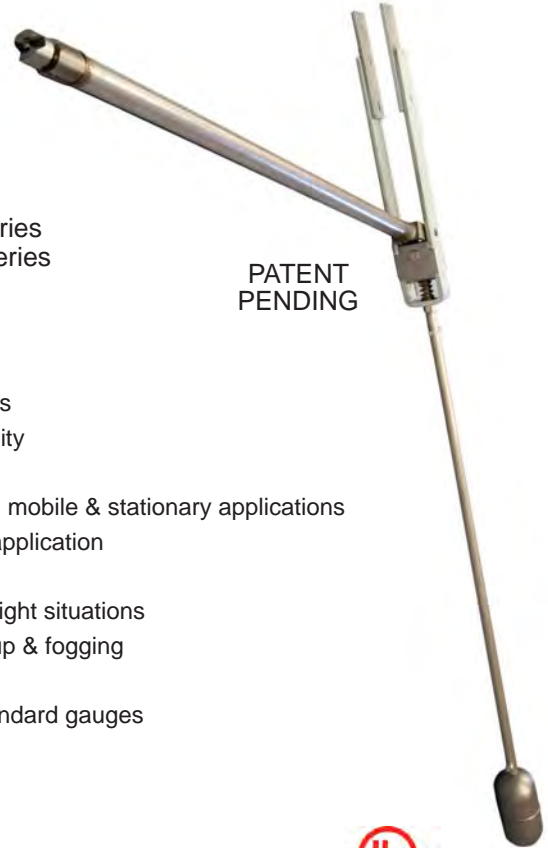

PATENT
PENDING

Trans-Max Float Gauge Features

- All stainless steel construction for use with LPG & NH₃ applications
- Welded tube to coupling design for maximum strength and durability
- Installation requires man-way
- Converts rotary style gauge to heavy duty Accu-Max style for both mobile & stationary applications
- Integral spring loaded shock absorber for arduous over-the-road application
- Easy to assemble
- Exclusive easy to read "glow in the dark" dial face perfect for low light situations
- Dial face 100% sealed and argon filled to prevent moisture build-up & fogging
- Factory set and precision tuned for superb accuracy
- Dial face and mounting hardware universal with other industry standard gauges
- Mounts to all standard 1" NPT tank coupling adapters
- Custom lengths available upon request
- Available with classic style dial face



Trans-Max Accu-Max DOT Float Gauges			
Part No.	Description	Dial Face	Tank Diameter
ME930WG-72	Trans-Max Accu-Max DOT Float Gauge Assembly	Glow/Black	72"
ME930WG-79	Trans-Max Accu-Max DOT Float Gauge Assembly	Glow/Black	79"
ME930WG-84	Trans-Max Accu-Max DOT Float Gauge Assembly	Glow/Black	84"
ME930CWG-72	Trans-Max Accu-Max DOT Float Gauge Assembly (Classic)	Silver/Black	72"
ME930CWG-79	Trans-Max Accu-Max DOT Float Gauge Assembly (Classic)	Silver/Black	79"
ME930CWG-84	Trans-Max Accu-Max DOT Float Gauge Assembly (Classic)	Silver/Black	84"

Trans-Max Accu-Max ASME Stationary Float Gauges			
Part No.	Description	Dial Face	Tank Diameter
ME940WG-108	Trans-Max Accu-Max Stationary Float Gauge Assembly	Glow/Black	108"
ME940WG-130	Trans-Max Accu-Max Stationary Float Gauge Assembly	Glow/Black	130"
ME940CWG-108	Trans-Max Accu-Max Stationary Float Gauge Assembly (Classic)	Silver/Black	108"
ME940CWG-130	Trans-Max Accu-Max Stationary Float Gauge Assembly (Classic)	Silver/Black	130"



Liquid Transfer Valves

This system provides a safe and economical way to evacuate liquid from a tank during an emergency or container relocation. Installing a Liquid Withdrawal Tank Valve (ME460 or ME462 Series) directly into a tank, allows you to have only one Liquid Transfer Shutoff Valve (ME449 or ME449S) attached to a Liquid Withdrawal Adapter (ME458 Series) on every delivery and service truck.

Opening Liquid Withdrawal Tank Valve

1. Slowly loosen cap to release any trapped LP-Gas thru relief hole. Remove the cap when venting stops. In case of a leak and venting does not stop, retighten the cap and use another approved method to withdraw the liquid. *When loosening the cap make sure the valve is not unthreading from the tank. Use two wrenches, if necessary, to secure the valve to the tank.*
2. The Liquid Transfer Shutoff Valve must be in the open position and securely attached to the Liquid Withdrawal Adapter before connecting to the Liquid Withdrawal Tank Valve.
3. Once the Shutoff Valve Assembly is tightly attached to the Tank Valve, close the Shutoff Valve Assembly. A popping sound actuating the Tank Valve will occur while closing the Shutoff Valve Assembly allowing the flow to be controlled by the Shutoff Assembly. *If the Tank Valve does not open after following steps 1-3, increase pressure downstream (Shutoff Valve side) to equalize pressure in the Tank Valve.*
4. Use Marshall Excelsior Leak Detector to check for leaks between each connection.

Closing Liquid Withdrawal Tank Valve

1. To shut the Tank Valve pressure in the tank must exceed 35 psig. Close the Shutoff Valve Assembly and disconnect the hose or piping.
2. Slowly open the Shutoff Valve Assembly to release any LP-Gas in the valve. If the tank pressure exceeds 35 psig the LP-Gas released to the air will cause the excess flow feature to close on the Tank Valve. If the Tank Valve does not completely shut, close the Shutoff Valve Assembly immediately. The Shutoff Valve Assembly must remain connected until all the LP-Gas can be removed and the container repaired.
3. After the Tank Valve excess flow feature has closed remove the Shutoff Valve Assembly. When disconnecting the assembly make sure the Tank Valve is not unthreading from the tank. Use two wrenches, if necessary, to secure the valve to the tank. Note: A small amount of bypass may occur through the excess flow check. Use caution when removing the Shutoff Valve Assembly.
4. Clean the top surface of the Tank Valve and place Tank Valve Cap back onto Tank Valve ensuring cap gasket is in place. Make sure the Tank Cap is placed tightly onto the Tank Valve.

Always use an adapter between the liquid transfer valve (ME449 Series) and the liquid withdrawal valve. Do not use the transfer valve and adapter for full time service. Extreme care must be used whenever liquid transfer of LP-Gas is in progress. Only persons trained in the proper method of transfer should attempt this type of operation. Reference NFPA #58 Liquefied Petroleum Gas Code Chapter 7, LP-Gas Liquid Transfer for additional information.



Liquid Transfer
Shutoff Valve
ME449
ME449S



Liquid Withdrawal
Adapter
ME458
ME458S



Liquid Withdrawal
Tank Valve
ME462
ME462S
ME462SS



ME461 Series
Cap included

Liquid Withdrawal
Tank Valve Cap
ME461

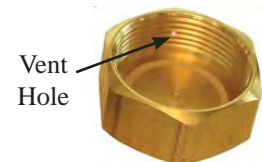

Liquid Transfer Valves & Adapters

Designed to provide a safe means by which to transfer liquid from a tank during an emergency or container relocation. These valves can be equipped with an integral excess flow device for direct product transfer or without when used in conjunction with liquid withdrawal adapter (ME458 Series) and tank valve (ME460 & ME462 Series).

Warning: An excess flow valve will not activate if there is a break or leak downstream of the valve that does not equal or exceed the closing flow of the valve or if the excess flow valve installed exceeds the flow capacity of the system. See the Excess Flow Warning page for more information regarding the use of excess flow devices.

Liquid Transfer Valve Features

- Double O-ring stem seal design ensures leak free operation
- Double lead stem thread ensures quick and efficient operation
- 3/4" MNPT inlet x 3/4" FNPT outlet
- Additional features for steel transfer valves
 - All stainless steel internal components
 - Durable ductile iron valve body with automotive grade powder coat finish
 - Equipped with convenient upstream and downstream 1/4" FNPT plugged ports for optional accessories



Tank Valve Features

- Provides excess flow protection in the event of a downstream connection or line failure
- Safety breakaway feature leaves valve seals intact in the event of truck roll-away
- 6-14 psig closing flow pressure differential for maximum product transfer
- Fully interchangeable with all existing valve models and adapters
- Additional features for steel and stainless steel tank valves
 - Meets requirements for installation into DOT storage containers like bobtails and transports
 - Steel model features a rust inhibitor compound between the cap and body threads to prevent corrosion



Part No.	Material	Excess Flow	Closing Flow/GPM	Accessories						Hydrostatic Relief Valve	Vent Valve
				Liquid Withdrawal Adapter 3/4" FNPT x 1-5/8" UNF		Liquid Withdrawal Tank Valve 1-5/8" UNF Male					
				Brass	Steel*	3/4" MNPT	1-1/4" MNPT				
							Brass	Steel*	Stainless Steel*		
ME449	Brass	No	—	ME458	ME458S	ME460***	ME462***	—	—	MEH225 MEH25/450	
ME449H	Brass	No	—	ME458	ME458S	—	—	—	—	Factory Installed MEH225	MEJ400
ME449S	Ductile Iron*	No	—	—	ME458S	—	—	ME462S***	ME462SS***		MEJ400SC
ME449EXS/22	Ductile Iron*	Yes	22	—	—	—	—	—	—	MEH225SS/350 MEH225SS/400 MEH225SS/440	MEJ400/72 MEJ402S
ME449EXS/28	Ductile Iron*	Yes	28	—	—	—	—	—	—		
ME450**	Brass	No	—	—	—	ME601-6	ME601-10	—	—		

* Rated for LP-Gas & NH₃

** MEJ400 Vent Valve Factory Installed

*** Includes an excess flow feature (ME460 = 21 GPM / ME462 = 36 GPM)



Liquid Transfer Adapters

Designed for use between the liquid transfer shutoff valve and the liquid withdrawal tank valve. These adapters enable the tank valve to open properly and allows a tight seal when transferring liquid. Special threads on the tank valve and the adapter help eliminate tampering.

The ME458 Series fits all new underwriters laboratories listed valves. The ME453 and ME455 fit older style liquid withdrawal tank valves that are still in service and have not been replaced. They will not provide a positive seal during actuation of liquid withdrawal tank valve until fully seated.

Part No.	Material	Inlet Connection	Outlet Connection
ME458	Brass	1-5/8" UNF	3/4" FNPT
ME458S*	Steel	1-5/8" UNF	3/4" FNPT
ME453	Brass	3/4" NGT	3/4" FNPT
ME455	Brass	3/4" NGT	3/4" MNPT

* Rated for LP-Gas & NH₃



Combination Valves

Developed to mount a pressure gauge and fixed tube liquid level gauge all in one valve. The shutoff portion of the valve increases the pressure gauge's life and accuracy by eliminating constant gauge pressure and allows for easy gauge replacement. To replace a gauge simply close the valve and open the vent valve to relieve pressure before disassembling pressure gauge.

The valve can be installed at the maximum fill level or an 1/8" MNPT dip tube can be installed on the container connection side to set any liquid level desired. For use in ASME bulk storage containers and DOT transport tank installations.

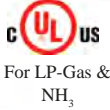

Combination Valve Features

- All steel and stainless steel component construction
- Integral #54 orifice provides gauge dampening protection
- Durable ductile iron body with automotive grade powder coat finish or plated steel body



Part No.	Material	Container Connection MNPT	Two Service Connections FNPT	Dip Tube Connection FNPT	Accessories	
					Stainless Steel Vent Valve	Stainless Steel 0-400 PSIG Pressure Gauge
ME830	Ductile Iron	3/4" MNPT	1/4" FNPT	1/8"	Included	MEJ526 MEJ542
MEJ415	Steel	3/4" MNPT	1/4" FNPT	1/8"	MEJ402S	MEJ542
MEJ415G	Steel	3/4" MNPT	1/4" FNPT	1/8"	Included	Included

Multipurpose Valves

Intended for use as a high capacity filler valve with a manual shut-off device in LPG or NH₃ containers. These valves can be equipped with either a soft seat back check or excess flow feature that is internal to the container. The excess flow version can also be used as a vapor equalizing valve typically found in NH₃ applicators and nurse tank applications.

Note: For proper operation and performance of the excess flow feature the manual shutoff must be completely open and back seated.

Multipurpose Valve Features

- Plated ductile iron body with 1/4" NPT auxillary plugged port
- All stainless steel internal construction for maximum corrosion resistance
- Supplied with ACME cap & chain assembly
- V-cup Teflon® packing stem seals
- Rated 400 PSI / WOG
- Removable data plate



For LP-Gas
& NH₃



ME670DBC



ME670DEX

MEC Multipurpose Filler / Withdrawal Valves

Part No.	Inlet (MNPT)	Fill Connection (M. Acme)	*GPM/LPG Fill Capacity	Approximate Excess Flow Closing Flow		Back Check	Accessories	
				*Liquid GPM/LPG	**Vapor SCFH/LPG		Hydrostatic Relief	Vent Valve
ME670DBC	1-1/4"	1-3/4"	100	N/A	N/A	Yes	MEH225***	MEJ400***
							MEH225SS	MEJ402S
ME670DEX****	1-1/4"	1-3/4"	100	58	27,000	No	MEH225***	MEJ400***
							MEH225SS	MEJ402S

* For NH₃ Flow Rates Multiply by .90

*** Brass accessories cannot be used for NH₃

** For NH₃ @ 100 PSI, Multiply by 1.6

**** Available for 45 GPM NH₃ closing flow - e.i. ME670DEX/45

The ME671DIBC is equipped with an integrated back check (IBC) feature built into the lower portion of the seat disc assembly. This feature allows liquid pressure built upstream of the shut-off disc assembly to automatically be relieved back to the container when line pressures exceed 10-25 PSI over container pressure. The (IBC) feature eliminates the need for hydrostatic relief valves to protect upstream piping or lines as well as greatly reducing product emissions and overall system safety.

MEC Multipurpose Withdrawal Valves

Part No.	Inlet (MNPT)	Withdrawal (FNPT)	Approximate Excess Flow Closing Flow Liquid GPM/LPG*	Back Check	Accessories	
					Hydrostatic Relief	Vent Valve
ME671DIBC-6	1-1/4"	3/4"	50	No	N/A	MEJ400**
					N/A	MEJ402S
ME671DIBC-8***	1-1/4"	1"	58	No	N/A	MEJ400**
					N/A	MEJ402S
ME671D-6	1-1/4"	3/4"	50	No	MEH225**	MEJ400**
					MEH225SS	MEJ402S
ME671D-8***	1-1/4"	1"	58	No	MEH225**	MEJ400**
					MEH225SS	MEJ402S
ME672D	1-1/4"	1"	78	No	MEH225**	MEJ400**
					MEH225SS	MEJ402S

* For NH₃ Flow Rates Multiply by .90

** Brass accessories cannot be used for NH₃ service

*** Available for 45 GPM NH₃ closing flow - e.i. ME671D-8/45



ME671D-8

ME672D



Multipurpose Filler / Withdrawal Valves

Intended for use as a high capacity combination filler and liquid withdrawal valve with a manual shut off device in LPG or NH₃ containers. These valves can be equipped with either a soft seat back check or excess flow feature that is internal to the container. Ideally suited for use in dispensing applications as a dual purpose high capacity tank filler valve as well as a liquid return line from the pump bypass valve.

Note: For proper operation and performance of the excess flow feature the manual shutoff must be completely open and back seated.

Multipurpose Filler / Withdrawal Valve Features

- Plated ductile iron body with 1/4" NPT auxillary plugged port
- All stainless steel internal construction for maximum corrosion resistance
- Supplied with ACME cap & chain assembly
- V-cup Teflon® packing stem seals
- Rated 400 PSI / WOG
- Removable data plate

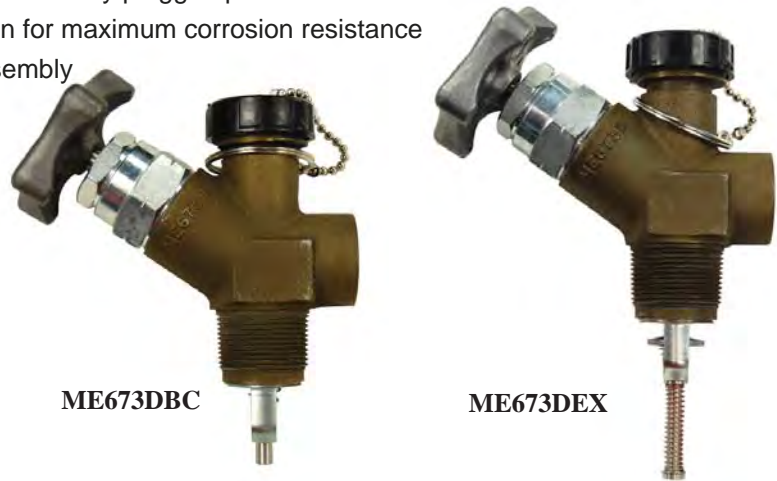

ME673DBC

ME673DEX

MEC Multipurpose Filler / Withdrawal Valves									
Part No.	Inlet (MNPT)	Fill Connection (M. Acme)	Withdrawal (FNPT)	*Fill Capacity GPM/LPG	Approximate Excess Flow Closing Flow		Back Check	Accessories	
					*Liquid GPM/LPG	**Vapor SCFH/LPG		Hydrostatic Relief	Vent Valve
ME673DEX-6****	1-1/4"	1-3/4"	3/4"	100	58	27,000	No	MEH225***	MEJ400***
								MEH225SS	MEJ402S
ME673DEX-8****	1-1/4"	1-3/4"	1"	100	58	27,000	No	MEH225***	MEJ400***
								MEH225SS	MEJ402S
ME673DBC-6	1-1/4"	1-3/4"	3/4"	100	N/A	N/A	Yes	MEH225***	MEJ400***
								MEH225SS	MEJ402S
ME673DBC-8	1-1/4"	1-3/4"	1"	100	N/A	N/A	Yes	MEH225***	MEJ400***
								MEH225SS	MEJ402S

* For NH₃ Flow Rates Multiply by .90

** For NH₃ @ 100 PSI, Multiply by 1.6

*** Brass accessories cannot be used for NH₃

****Available for 45 GPM NH₃ closing flow - e.i. ME673DEX-6/45

1-1/4" Threaded Internal Valve

Intended for use on bobtail trucks and storage tanks with 1-1/4" threaded connections in directional or bi-directional flow applications. Provides both manual shut-down as well as excess flow closing in the event of the piping being separated from the valve. Can be equipped with manual latch, pneumatic or rotary actuator, open/ closing devices. All valve models are equipped with a break-away feature in the cast body which permits the piping to shear off in the event of side impact, leaving the valve poppet intact and protecting the tank from catastrophic product loss. For liquid or vapor service applications.

1-1/4" Threaded Internal Valve Features

- Standardized 316 stainless steel cast body for maximum durability and corrosion resistance
- All stainless internal component construction
- Hexagonal installation flats to fit standard 2-3/8" hex socket wrench
- Precision machined hard coated stem
- Fully retained Nitrile seat disc
- Large variety of excess flow closing values
- Roller cam actuation
- Industry's fastest bleed time
- Removable data plate
- Industry's easiest valve to service
- Standard construction utilizes Nitrile seals
- Available with Neoprene, Viton®, or Kalrez® seals
- UL LISTED for LPG & NH₃ service
- Rulon™ bearing on stub shaft



ME990M-10 Series

"X"	1-1/4" Valve Liquid Closing Flow Values
35	35 GPM LPG Closing Flow
55	55 GPM LPG Closing Flow
85	85 GPM LPG Closing Flow
* For NH ₃ multiply GPM by .90	

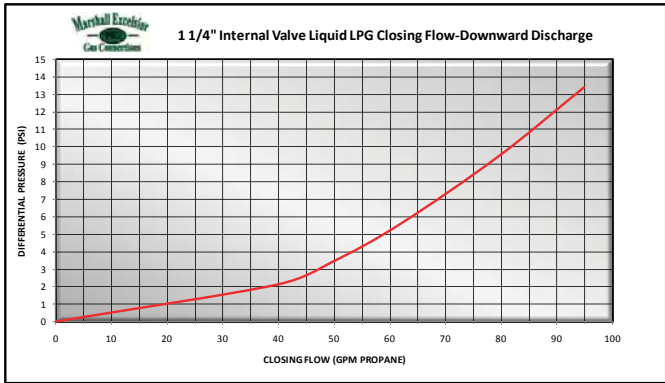

MEC Excelerator™ 1-1/4" Threaded Internal Valves	
Part No. *	Description
ME990-10-"X"	Excelerator™ 1-1/4" MNPT x 1-1/4" FNPT Internal Valve - Only
ME990A-10-"X"	Excelerator™ 1-1/4" MNPT x 1-1/4" FNPT Internal Valve - with Pneumatic Actuator
ME990AR-10-"X"	Excelerator™ 1-1/4" MNPT x 1-1/4" FNPT Internal Valve - with Rotary Actuator
ME990M-10-"X"	Excelerator™ 1-1/4" MNPT x 1-1/4" FNPT Internal Valve - with Manual Latch
*Note: Indicate desired excess flow closing value when ordering - see chart for values i.e. ME990-10-85 (85 GPM) To order Kalrez® add "K" for Kalrez® after the prefix part number i.e. ME990K-10-35 To order Neoprene add "N" for Neoprene after the prefix part number i.e. ME990N-10-35 To order Viton® add "V" for Viton® after the prefix part number i.e. ME990V-10-35	

Viton® and Kalrez® are trademarks of DuPont Performance Elastomers.



1-1/4" Threaded Tee Body Internal Valves

Intended for use on bobtail trucks and storage tanks with 1-1/4" threaded connections in directional or bi-directional flow applications. Provides both manual shut-down as well as excess flow closing in the event of the piping being seperated from the valve. Can be equipped with manual latch, pneumatic or rotary actuator, open/ closing devices. All valve models are equipped with a break-away feature in the cast body which permits the piping to shear off in the event of side impact, leaving the valve poppet intact and protecting the tank from catastrophic product loss. The tee body features an additional FNPT side discharge port . For liquid or vapor service applications.

1-1/4" Threaded Tee Body Internal Valve Features

- Standardized 316 stainless steel cast body for maximum durability and corrosion resistance
- All stainless internal component construction
- Precision machined hard coated stem
- Fully retained nitrile seat disc
- Large variety of excess flow closing values
- Roller cam actuation
- Industry's fastest bleed time
- Removable data plate
- Industry's easiest valve to service
- Standard construction utilizes nitrile seals
- Available with Neoprene, Viton®, or Kalrez® seals
- UL LISTED for LPG & NH₃ service
- RulonTM bearings on stem and stub shafts



ME992-10
1-1/4" NTP Tee Body
Internal Valve
w/ Manual Latch



"X"	1-1/4" Valve Liquid Closing Flow Values
35	35 GPM LPG Closing Flow
55	55 GPM LPG Closing Flow
85	85 GPM LPG Closing Flow

* For NH₃ multiply GPM by .90

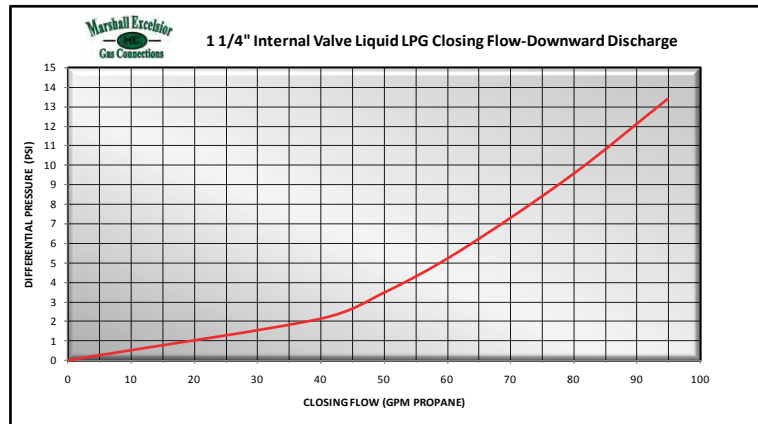

MEC Excelsior TM 1-1/4" Threaded Tee Body Internal Valves	
Part No. *	Description
ME992-10-"X"	Excelsior TM 1-1/4" MNPT x 1-1/4" FNPT Internal Valve - Only
ME992A-10-"X"	Excelsior TM 1-1/4" MNPT x 1-1/4" FNPT Internal Valve - with Pneumatic Actuator
ME992AR-10-"X"	Excelsior TM 1-1/4" MNPT x 1-1/4" FNPT Internal Valve - with Rotary Actuator
ME992M-10-"X"	Excelsior TM 1-1/4" MNPT x 1-1/4" FNPT Internal Valve - with Manual Latch

* Note: Indicate desired excess flow closing value when ordering - see chart for values
 i.e. ME992-10-85 (85 GPM)
 To order Kalrez® add "K" for Kalrez® after the prefix part number i.e. ME992K-10-35
 To order Neoprene add "N" for Neoprene after the prefix part number i.e. ME992N-10-35
 To order Viton® add "V" for Viton® after the prefix part number i.e. ME992V-10-35



Viton® and Kalrez® are trademarks of DuPont Performance Elastomers.

MECTM ExcelelatorTM 2" & 3" Threaded Internal Valves

Intended for use on transport trucks and large storage tanks with 2" or 3" threaded connections in directional or bi-directional flow applications. Provides both manual shut-down and excess flow closing in the event of the piping being separated from the valve. Can be equipped with manual latch, pneumatic or rotary actuator open/ closing devices. All valve models are equipped with a break-away feature in the cast body which permits the piping to shear off in the event of side impact, leaving the valve poppet intact and protecting the tank from catastrophic product loss. For liquid or vapor service applications

2" & 3" Threaded Internal Valve Features

- Durable ductile body with cadmium surface plating
- All stainless internal component construction
- One piece threaded packing gland
- Precision machined hard coated stem
- Fully retained Nitrile seat disc
- Largest variety of excess flow closing values
- Roller cam actuation
- Industry's fastest bleed time
- Removable data plate
- Industry's easiest valve to service
- Standard construction utilizes Nitrile seals
- Available with Neoprene, Viton[®], or Kalrez[®] seals
- UL LISTED for LPG & NH₃ service
- RulonTM bearings on stem and stub shafts

ME990M-16 Series



ME990-24 Series



Excelelator
Internal Valves

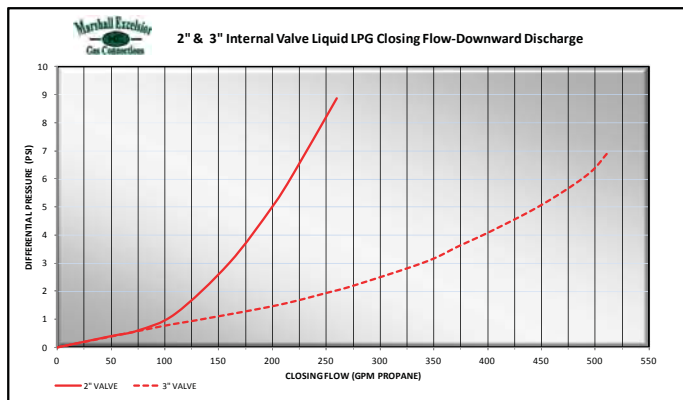

"X"	2" Valve Liquid Closing Flow Values
110	110 GPM LPG Closing Flow
160	160 GPM LPG Closing Flow
260	260 GPM LPG Closing Flow

"X"	3" Valve Liquid Closing Flow Values
175	175 GPM LPG Closing Flow
250	250 GPM LPG Closing Flow
300	300 GPM LPG Closing Flow
375	375 GPM LPG Closing Flow
400	400 GPM LPG Closing Flow
475	475 GPM LPG Closing Flow
500	500 GPM LPG Closing Flow

MEC Excelelator TM 2" & 3" Threaded Internal Valves	
Part No. *	Description
ME990-16-"X"	Excelelator TM 2" MNPT x 2" FNPT Internal Valve - Only
ME990A-16-"X"	Excelelator TM 2" MNPT x 2" FNPT Internal Valve - with Pneumatic Actuator
ME990AR-16-"X"	Excelelator TM 2" MNPT x 2" FNPT Internal Valve - with Rotary Actuator
ME990M-16-"X"	Excelelator TM 2" MNPT x 2" FNPT Internal Valve - with Manual Latch
ME990-24-"X"	Excelelator TM 3" MNPT x 3" FNPT Internal Valve - Only
ME990A-24-"X"	Excelelator TM 3" MNPT x 3" FNPT Internal Valve - with Pneumatic Actuator
ME990AR-24-"X"	Excelelator TM 3" MNPT x 3" FNPT Internal Valve - with Rotary Actuator
ME990M-24-"X"	Excelelator TM 3" MNPT x 3" FNPT Internal Valve - with Manual Latch
*Note: Indicate desired excess flow closing value when ordering - see chart for values i.e. ME990-24-250 (250 GPM) Note: Available in all Stainless Steel Construction To order Kalrez [®] add "K" for Kalrez [®] after the prefix part number i.e. ME990K-16-160 To order Neoprene add "N" for Neoprene after the prefix part number i.e. ME990N-16-160 To order Viton [®] add "V" for Viton [®] after the prefix part number i.e. ME990V-16-160	



Viton[®] and Kalrez[®] are trademarks of DuPont Performance Elastomers.

2" & 3" Threaded Tee Body Internal Valves

Intended for use on transport trucks and large storage tanks with 2" or 3" threaded connections in directional or bi-directional flow applications. Provides both manual shut-down and excess flow closing in the event of the piping being separated from the valve. Can be equipped with manual latch, pneumatic or rotary actuator open/ closing devices. All valve models are equipped with a break-away feature in the cast body which permits the piping to shear off in the event of side impact, leaving the valve poppet intact and protecting the tank from catastrophic product loss. The tee body features an additional FNPT side discharge port. For liquid or vapor service applications.

2" & 3" Threaded Tee Body Internal Valve Features

- Durable ductile body with cadmium surface plating
- All stainless internal component construction
- One piece threaded packing gland
- Precision machined hard coated stem
- Fully retained nitrile seat disc
- Largest variety of excess flow closing values
- Roller cam actuation
- Industry's fastest bleed time
- Removable data plate
- Industry's easiest valve to service
- Standard construction utilizes nitrile seals
- Available with Neoprene, Viton®, or Kalrez® seals



ME992M-16
2" NTP Tee Body Internal Valve w/ Manual Latch



ME992M-24
3" NTP Tee Body Internal Valve w/ Manual Latch

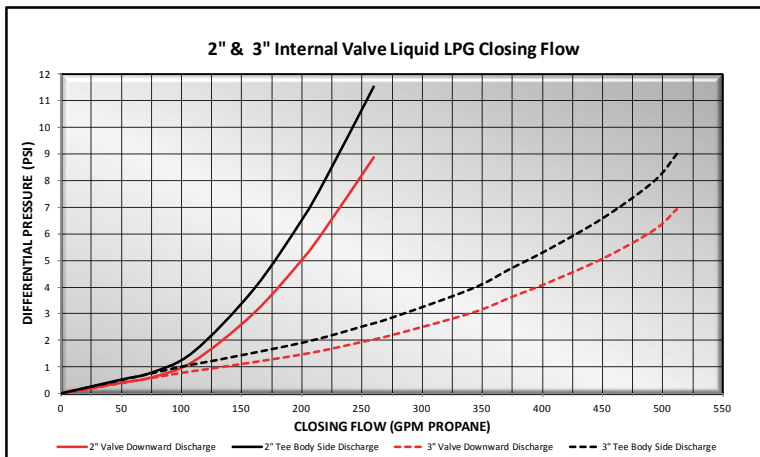

"X"	2" Valve Liquid Closing Flow Values
110	110 GPM LPG Closing Flow
160	160 GPM LPG Closing Flow
260	260 GPM LPG Closing Flow

"X"	3" Valve Liquid Closing Flow Values
175	175 GPM LPG Closing Flow
250	250 GPM LPG Closing Flow
300	300 GPM LPG Closing Flow
375	375 GPM LPG Closing Flow
475	475 GPM LPG Closing Flow
500	500 GPM LPG Closing Flow

For NH₃ multiply GPM by .90
Side discharge increases differential to close by approx. 2 PSIG

MEC Excelsior™ 2" & 3" Threaded Tee Body Internal Valves	
Part No. *	Description
ME992-16-"X"	Excelsior™ 2" MNPT x 2" FNPT Tee Body Internal Valve - Only
ME992A-16-"X"	Excelsior™ 2" MNPT x 2" FNPT Tee Body Internal Valve - with Pneumatic Actuator
ME992AR-16-"X"	Excelsior™ 2" MNPT x 2" FNPT Tee Body Internal Valve - with Rotary Actuator
ME992M-16-"X"	Excelsior™ 2" MNPT x 2" FNPT Tee Body Internal Valve - with Manual Latch
ME992-24-"X"	Excelsior™ 3" MNPT x 3" FNPT Tee Body Internal Valve - Only
ME992A-24-"X"	Excelsior™ 3" MNPT x 3" FNPT Tee Body Internal Valve - with Pneumatic Actuator
ME992AR-24-"X"	Excelsior™ 3" MNPT x 3" FNPT Tee Body Internal Valve - with Rotary Actuator
ME992M-24-"X"	Excelsior™ 3" MNPT x 3" FNPT Tee Body Internal Valve - with Manual Latch

*Note: Indicate desired excess flow closing value when ordering - see chart for values - i.e. ME992-24-250 (250 GPM)
To order Kalrez® add "K" for Kalrez® after the prefix part number i.e. ME992K-16-160
To order Neoprene add "N" for Neoprene after the prefix part number i.e. ME992N-16-160
To order Viton® add "V" for Viton® after the prefix part number i.e. ME992V-16-160



MEC Excelerator™ 2" & 3" Flanged Internal Valves

Intended for use on bobtail delivery trucks, transport trucks and large storage tanks with 2" or 3" flanged connections in directional or bi-directional flow applications. Provides both manual shut-down and excess flow closing in the event of the piping being separated from the valve. Can be equipped with manual latch, pneumatic or rotary actuator open/ closing devices. All valve models are equipped with a break-away feature in the cast body which permits the pump or piping to shear off in the event of side impact, leaving the valve poppet intact and protecting the tank from catastrophic product loss.

2" & 3" Flanged Internal Valve Features

- Durable steel body with cadmium surface plating
- All stainless internal component construction
- One piece threaded packing gland
- Precision machined hard coated stem & stem guide
- Fully retained Nitrile seat disc
- Largest variety of excess flow closing values
- Corrosion resistant sleeved flange bolt holes
- Xylan coated corrosion resistant mounting studs
- Roller cam actuation
- Industry's fastest bleed time
- Removable data plate
- Industry's easiest valve to service
- Standard construction utilizes Nitrile seals
- Available with Neoprene, Viton®, or Kalrez® seals
- Available with 316 Stainless Steel bodies
- UL LISTED for LPG & NH₃ service
- Rulon™ bearings on stem and stub shafts

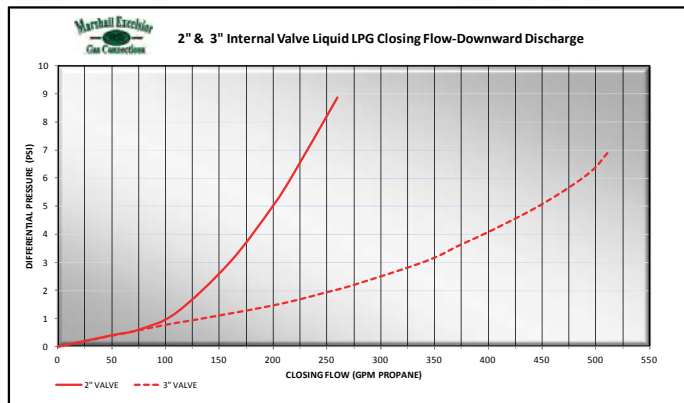

"X"	3" Valve Liquid Closing Flow Values
175	175 GPM LPG Closing Flow
250	250 GPM LPG Closing Flow
300	300 GPM LPG Closing Flow
375	375 GPM LPG Closing Flow
400	400 GPM LPG Closing Flow
475	475 GPM LPG Closing Flow
500	500 GPM LPG Closing Flow

For NH₃ Multiply GPM by .90



"X"	2" Valve Liquid Closing Flow Values
110	110 GPM LPG Closing Flow
160	160 GPM LPG Closing Flow
260	260 GPM LPG Closing Flow

MEC Excelerator™ 2" & 3" Flanged Internal Valves	
Part No. *	Description
ME990S-2F-16-"X"	Excelerator™ 2"-300 lb. Modified Single Flange Internal Valve - Only
ME990SA-2F-16-"X"	Excelerator™ 2"-300 lb. Modified Single Flange Internal Valve - with Pneumatic Actuator
ME990SAR-2F-16-"X"	Excelerator™ 2"-300 lb. Modified Single Flange Internal Valve - with Rotary Actuator
ME990S-3DF-"X"	Excelerator™ 3" Double Flange Bobtail Internal Valve - Only
ME990SA-3DF-"X"	Excelerator™ 3" Double Flange Bobtail Internal Valve - with Pneumatic Actuator
ME990SAR-3DF-"X"	Excelerator™ 3" Double Flange Bobtail Internal Valve - with Rotary Actuator
ME990S-3DFM-"X"	Excelerator™ 3"-300 lb. Modified Double Flange Internal Valve - Only
ME990SA-3DFM-"X"	Excelerator™ 3"-300 lb. Modified Double Flange Internal Valve - with Pneumatic Actuator
ME990SAR-3DFM-"X"	Excelerator™ 3"-300 lb. Modified Double Flange Internal Valve - with Rotary Actuator
ME990S-3F-24-"X"	Excelerator™ 3"-300 lb. Modified Single Flange x 3" FNPT Internal Valve - Only
ME990SA-3F-24-"X"	Excelerator™ 3"-300 lb. Modified Single Flange x 3" FNPT Internal Valve - with Pneumatic Actuator
ME990SAR-3F-24-"X"	Excelerator™ 3"-300 lb. Modified Single Flange x 3" FNPT Internal Valve - with Rotary Actuator

* Note: Indicate desired excess flow closing value when ordering - see chart for values i.e. ME990S-3SF-250 (250 GPM)
 Available in all Stainless Steel Construction
 To order Kalrez® add "K" for Kalrez® after the prefix part number i.e. ME990SK-SDF-300
 To order Neoprene add "N" for Neoprene after the prefix part number i.e. ME990SN-SDF-300
 To order Viton® add "V" for Viton® after the prefix part number i.e. ME990SV-SDF-300



Viton® and Kalrez® are trademarks of DuPont Performance Elastomers.



Next Generation Excelerator™ 3" Double Flanged Off-Set Internal Valves

Intended for use on bobtail delivery trucks with 3" flanged connections in directional or bi-directional flow applications. The 3" offset outlet flange prevents pump installation interference with truck frame rails, cross members, PTO covers, drive shafts, and other common obstacles when remounting bobtail vessels onto new chassis. In order to reduce the amount of offset from the 2" maximum to 1-1/4", simply rotate the inlet flange connection by 1 bolt hole either direction. To eliminate the offset entirely, simply rotate 1 more bolt hole. The Excelerator™ offset is equipped with three separate packing gland locations to prevent interference while mounting the valve actuator no matter how you choose to mount the valve. Provides both manual shut-down and excess flow closing in the event the of the valve being separated from the tank. Can be equipped with pneumatic or rotary actuator open/closing devices. All valve models are equipped with a break-away feature in the cast body which permits the pump or piping to shear off in the event of side impact, leaving the valve poppet intact and protecting the tank from catastrophic product loss.

- Body outlet flange offset 2" from inlet flange
- Rotate valve body in either direction 1 bolt hole to reduce offset to 1-1/4"
- Standard with 3 gland ports for stem relocation (2 plugged)
- Each gland port can accept pneumatic or rotary type actuators
- Durable steel body with cadmium surface plating
- All stainless internal component construction
- One piece threaded packing gland
- Precision machined hard coated stem & stem guide
- Fully retained nitrile seat disc
- Largest variety of excess flow closing values
- Corrosion resistant sleeved flange bolt holes
- Xylan coated corrosion resistant mounting studs
- Roller cam actuation
- Industry's fastest bleed time
- Removable data plate
- Industry's easiest valve to service
- Standard construction utilizes nitrile seals
- Available with Neoprene, Viton®, or Kalrez® seals
- Available with 316 Stainless Steel bodies
- UL LISTED for LPG & NH₃ service
- Rulon™ bearings on stem and stub shafts

ME990S-3DFO

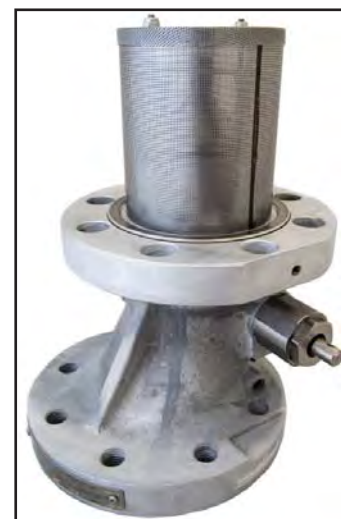

Alternate Gland Ports (Plugged)

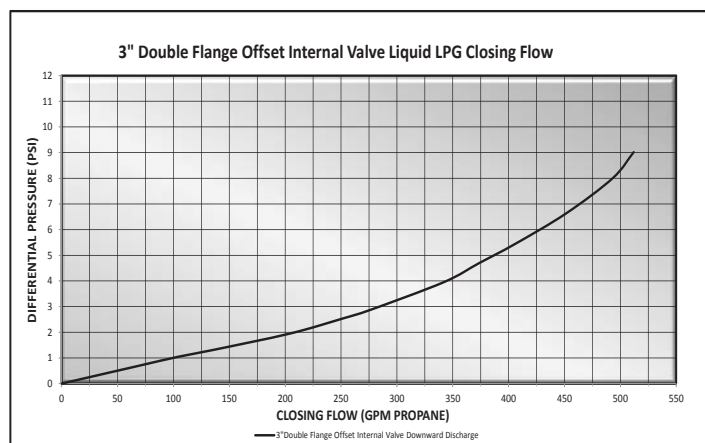

"X"	3" Valve Liquid Closing Flow Values
175	175 GPM LPG Closing Flow
250	250 GPM LPG Closing Flow
300	300 GPM LPG Closing Flow
375	375 GPM LPG Closing Flow
400	400 GPM LPG Closing Flow
475	475 GPM LPG Closing Flow
500	500 GPM LPG Closing Flow

For NH₃ Multiply GPM by .90



MEC Excelerator™ 3" Double Flanged Offset Internal Valves	
Part No. *	Description
ME990S-3DFO-"X"	Excelerator™ 3" Double Flange Offset Bobtail Internal Valve - Only
ME990SA-3DFO-"X"	Excelerator™ 3" Double Flange Offset Bobtail Internal Valve - with Pneumatic Actuator
ME990SAR-3DFO-"X"	Excelerator™ 3" Double Flange Offset Bobtail Internal Valve - with Rotary Actuator

*Note: Indicate desired excess flow closing value when ordering - see chart for values i.e. ME990S-3DFO-250 (250 GPM)
 Available in all Stainless Steel Construction
 To order Kalrez® add "K" for Kalrez® after the prefix part number i.e. ME990SK-3DFO-300
 To order Neoprene add "N" for Neoprene after the prefix part number i.e. ME990SN-3DFO-300
 To order Viton® add "V" for Viton® after the prefix part number i.e. ME990SV-3DFO-300

MEC Excelerator™ 4" Flanged Internal Valves

Intended for use on transport trucks and large storage tanks with 4" flanged connections in directional or bi-directional flow applications. Provides both manual shut-down as well as excess flow closing in the event of the piping being separated from the valve. Can be equipped with manual latch, pneumatic or rotary actuator open/ closing devices.

4" Flanged Internal Valve Features

- All stainless construction
- Precision machined stem & stem guide
- Fully retained disc
- Largest variety of excess flow closing values
- Available with standard or #5 mesh filter screen
- Corrosion resistant sleeved flange bolt holes
- Xylan coated corrosion resistant mounting studs
- Removable data plate
- Threaded packing gland with seal ejector spring
- Standard construction utilizes Nitrile seals
- Available with Neoprene, Viton®, or Kalrez® seals
- UL LISTED for LPG & NH₃ service
- Rulon™ bearings on stem and stub shafts

Excelerator
Internal Valves



MEC Excelerator™ 4" Internal Valves	
Part No. *	Description
ME990-4F-"X"	Excelerator™ 4" Single Flange Internal Valve - Only
ME990A-4F-"X"	Excelerator™ 4" Single Flange Internal Valve - with Pneumatic Actuator
ME990AR-4F-"X"	Excelerator™ 4" Single Flange Internal Valve - with Rotary Actuator
ME990M-4F-"X"	Excelerator™ 4" Single Flange Internal Valve - with Manual Latch

* Note: Indicate desired excess flow closing value when ordering - see chart for values
 i.e. ME990-4F-650 (650 GPM)
 For #5 Mesh screen add /5 e.i. ME990-4F-650/5
 To order Kalrez® add "K" for Kalrez® after the prefix part number i.e. ME990AK-4F-500
 To order Neoprene add "N" for Neoprene after the prefix part number i.e. ME990AN-4F-500
 To order Viton® add "V" for Viton® after the prefix part number i.e. ME990AV-4F-500



"X"	4" Valve Liquid Closing Flow Values
375	375 GPM LPG Closing Flow
500	500 GPM LPG Closing Flow
650	650 GPM LPG Closing Flow
850	850 GPM LPG Closing Flow
1250	1,250 GPM LPG Closing Flow
1500	1,500 GPM LPG Closing Flow

* For NH₃ Multiply GPM by .90

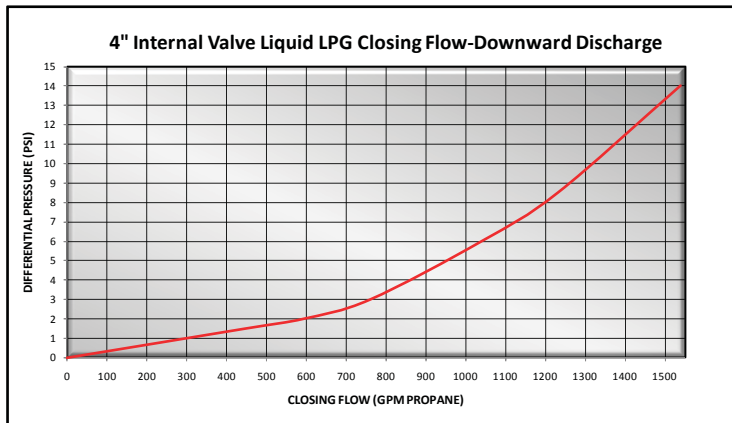

Actuator Accessories

ME707—The quick release valve is used in conjunction with Marshall Excelsior’s air actuators to decrease the response time when closing actuators. They are particularly effective when long distances (75 feet or more) exist between the actuator and the actuator control valve.

ME708—The 0-150 psig air pressure regulator prolongs the life of the air actuator and air system by allowing the air pressure to be set and regulated at the minimum required operating pressure for each individual system.

ME709—The gas/air filter is used to filter foreign materials and/or particles from LP-Gas systems such as motor fuel/carburetion systems. Also designed to be used to filter air supply lines for internal and emergency shutoff valve actuator systems.



ME707



ME708
Universal
Mounting
Bracket
Included



ME709

Part No.	Inlet	Outlet
ME707	3/8" FNPT	3/8" FNPT (2 Ports)
ME708	1/4" FNPT	1/4" FNPT
ME709	1/4" FNPT	1/4" MNPT

Internal Valve Actuators

PowerTorq Rotary Actuators

These direct drive actuators are designed to maximize the life of the internal valve by eliminating side pressure on the valve’s packing stem. These actuators are intended to be used at remote locations or operated directly off the air brake system in bobtail or transport applications.

The low temperature factory installed seals allow these actuators to be used with air, nitrogen, carbon dioxide or LP-Gas vapor. In case of a fire the factory provided thermal plug melts at 212° Fahrenheit releasing pressure allowing the internal valve to close. The factory set rotation of these actuators require no modification, can be oriented in any direction and all hardware needed for installation is provided.

PowerTorq Rotary Actuator Features

- Stainless steel all weather mounting hardware
- Field repairable under full tank pressure
- Anodized aluminum actuator body with easy to see open/close indicator
- No pinch points for operator safety
- Includes mounting bracket for ME707 Quick Release Valve

Note: ME707 is not required for operation



ME225

Actuator Operating Pressure Limits:

Minimum = 25 PSIG
Maximum = 125 PSIG
Recommended = 40-60 PSIG

PowerTorq Actuators

Part No.	Actuator Type	Fits MEC*	Fits Fisher*	Internal Valve
ME225	Direct Drive	ME990-10	Fisher® C407	1-1/4" Threaded
ME226	Direct Drive	ME990-16, ME990-24, ME990S-3F-24	Fisher® C402, C421, C427, C471, C477	2" & 3" Threaded
ME227	Direct Drive	ME990S-3DF & ME990S-3DFM	Fisher® C403-24 & C483-24 Series	3" Double Flange
ME228	Direct Drive	ME990-4F	Fisher® C404-32 & C484-32 Series	4" Single Flange

* Also fits Cavagna 6902900 Series internal valves

Fisher® and Fisher® Internal Valves are the trademarks of Emerson Process Management; Cavagna is the trademark of Cavagna Group



ME227

Internal Valve Actuators

PowerStroke and FaStroke Actuators

Designed with a heavy duty stainless steel frame to withstand the toughest conditions. These actuators are intended to be used at remote locations or operated directly off the air brake system in bobtail or transport applications.

The actuator's smooth acting cam opens the internal valve lever when air, nitrogen, or carbon dioxide is applied to the line. When pressure to the line is released, the internal valve automatically closes. In case of a fire the factory provided thermal plug melts at 212° Fahrenheit releasing pressure allowing the internal valve to close. These actuators require no modification and all hardware needed for installation is provided.

Part No.	Actuator Type	Fits MEC*	Fits*	Internal Valve
ME205	Airstroke™ by Firestone	ME990-10	Fisher® C407	1-1/4" Threaded
ME205R	Airstroke™ by Firestone	—	RegO® A3209R	1-1/4" Threaded
ME206	#9 Chamber	ME990-16, ME990-24, ME990S-3F-24	Fisher® C402, C421, C471, C427, C477	2" & 3" Threaded
ME207	#9 Chamber	ME990S-3DF & ME990S-3DFM	Fisher® C403-24 & C483-24 Series	3" Double Flange
ME207SF	#9 Chamber	—	Fisher® C404-24 Series	3" Single Flange
ME208SF	#24 Chamber	ME990-4F	Fisher® C404-32 & C484-32 Series	4" Single Flange
ME710	Airstroke™ by Firestone	—	RegO® Flowmatic® Three-Way Valve	

* Also fits Cavagna 6902900 Series internal valves



ME205

FaStroke Actuators



ME205R

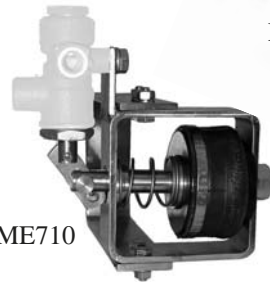

ME710

Actuator Operating Pressure Limits:

- Minimum = 20 PSIG
- Maximum = 125 PSIG
- Recommended = 20-25 PSIG

FaStroke & PowerStroke Actuator Features

- Stainless steel all weather bracket
- Field repairable without complete disconnect from internal valve
- Repairable with common automotive brake chamber
- High gloss automotive grade black epoxy coating

PowerStroke Actuators



ME206



ME208SF



ME207

*Internal valves not included

Airstroke™ is a trademark of Firestone Industrial Products Company, Fisher® and Fisher® Internal Valves are the trademarks of Emerson Process Management; RegO® and Flomatic® Internal Valves are the trademarks of Engineered Controls International, Inc. and Cavagna is the trademark of Cavagna Group



Made in the U.S.A.

Internal Valve Accessories



ME990-10-902



MEP990-24



MEP990-4F

Latches	
Part No.	Description
ME990-10-902	Excelerator™ Manual Latch Assembly for 1-1/4" Threaded Internal Valves
MEP990-24	Excelerator™ Manual Latch Assy For ME990-16 & 990-24 Series
MEP990-4F	Excelerator™ Manual Latch Assy For ME990-4F Series

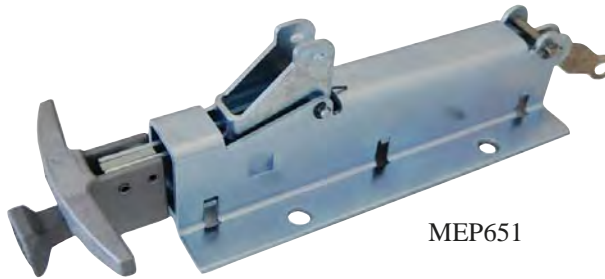

MEP651

Releases	
Part No.	Description
MEP650	Excelerator™ Open/Close Cable Control Release with 50' Cable
MEP651	Excelerator™ Open/Close Cable Control Release - Only

ESV Accessories



ME980-905-25

Part No.	Description
ME980-905	Universal ESV/Internal Valve Remote Release / No Cable
ME980-905-25	Universal ESV/Internal Valve Remote Release W/ 25' Cable
ME980-905-50	Universal ESV/Internal Valve Remote Release W/ 50' Cable
ME980-906-25	Remote Release Cable Assy. 5/16-24UNF - 25' OAL
ME980-906-50	Remote Release Cable Assy. 5/16-24UNF - 50' OAL

Emergency Shutoff Valve Actuators

Designed to be used with emergency shutoff valves in remote locations. Pressure to the line enables a smooth acting cam to completely open the emergency shutoff valve for full flow operation. When pressure to the line is released, the emergency shutoff valve automatically closes. In case of a fire a thermal plug melts at 212° Fahrenheit releasing pressure allowing the ESV to close. These actuators require no modification and all hardware needed for installation is provided.

The PowerTorq direct drive actuator maximizes the life of the emergency shutoff valve by eliminating side pressure on the valve's packing stem.

PowerTorq Rotary Actuator Features

- Stainless steel all weather mounting hardware
- Field repairable under full tank pressure
- Low temperature factory installed seals allow use with air, nitrogen, carbon dioxide or LP-Gas vapor
- Anodized aluminum actuator body with easy to see open/close indicator
- No pinch points for operator safety
- Factory installed thermal plug
- Includes mounting bracket for ME707 Quick Release Valve. Note: ME707 is not required for operation

PowerTorq



Actuator Operating Pressure Limits:

Minimum = 25 PSIG
 Maximum = 125 PSIG
 Recommended = 40-60 PSIG

SafetyStroke Actuator Features

- Heavy duty stainless steel all weather bracket
- Use with air, nitrogen or carbon dioxide
- Uses existing Fisher® thermal plug

SAFETY STROKE



ME980 Series
 Emergency Shutoff Valves
 not included

Part No.	Actuator Type	Fits MEC	Fits	ESV
ME551	Airstroke™ by Firestone	ME980-10, ME980-16, ME980-16-2F, ME980-24, ME980-24-3F, ME980-24-4F	Fisher® N550 Series	1-1/4", 2" & 3"
ME552	Direct Drive	ME980-10, ME980-16, ME980-16-2F, ME980-24, ME980-24-3F, ME980-24-4F	Fisher® N550 Series	1-1/4", 2" & 3"

Actuator Operating Pressure Limits:

Minimum = 20 PSIG
 Maximum = 125 PSIG
 Recommended = 20-25 PSIG

Airstroke™ is a trademark of Firestone Industrial Products Company, Fisher® and Fisher® Internal Valves are the trademarks of Emerson Process Management



3/4" & 1" Emergency Shutoff Valves

Emergency Shutoff Valves (ESV's) are designed to provide rapid and positive shutdown of gas lines should a down stream rupture or piping break occur. Due to the presence of a built-in fusible element at the valve operating hub the ESV will automatically close when exposed to heat between 212° F. - 250° F. These valves are ideally suited for installation at direct fired vaporizer inlets for automatic emergency shutdown as a result of fire or at dispensing pump inlets to provide immediate and positive remote shutdown.



ME980C-6

Emergency Shutoff Valve Features

- Powder coated ductile iron body with cast hexagonal ends for maximum durability and ease of installation
- Integral swing away check valve with soft seat to promote maximum product flow and minimize product loss in the event of a line failure
- All stainless steel internal component construction provides maximum corrosion resistance
- Provides clear visual indication if valve is open / closed
- UL LISTED for use with LP Gas and Anhydrous Ammonia - 400 PSI WOG
- Integral fusible element for automatic closure when exposed to fire
- Durable Teflon® packing gland and resilient seals provide long lasting service life
- Available with pneumatic or cable style latch mechanism

Part No.	Description	Latch Type	OAL
ME980-6	3/4" FNPT Emergency Shutoff Valve (ESV)	Pneumatic	4-3/4"
ME980-8	1" FNPT Emergency Shutoff Valve (ESV)	Pneumatic	4-3/4"
ME980C-6	3/4" FNPT Emergency Shutoff Valve (ESV)	Cable	4-3/4"
ME980C-8	1" FNPT Emergency Shutoff Valve (ESV)	Cable	4-3/4"



3/4" & 1" Flow Indicating Swing Check Valves

Promotes maximum pump efficiency by providing system operators with a visual inspection point for monitoring liquid flow conditions as well as providing a soft seat back check valve should product flow reverse for any reason. Installation of a flow indicating swing check valve upstream of the pump, allows the operator to observe product flow and make pump adjustments for maximum flow without cavitation. Suitable for stationary and mobile applications.



ME981-6

Flow Indicating Swing Check Valve Features

- Powder coated ductile iron body with cast hexagonal ends for maximum durability and ease of installation
- Integral swing away check valve with soft seat to promote maximum product flow and minimize product loss in the event of a line failure
- All stainless steel internal component construction provides maximum corrosion resistance
- Clear / Easy to read flow indicator allows the operator to easily see if the valve is open or closed
- UL LISTED for use with LP Gas and Anhydrous Ammonia - 400 PSI WOG

Part No.	Description	Material	OAL
ME981-6	3/4" FNPT Flow Indicating Check Valve	Ductile Iron	4-3/4"
ME981-8	1" FNPT Flow Indicating Check Valve	Ductile Iron	4-3/4"

1-1/4" - 3" Emergency Shutoff Valves

Emergency Shutoff Valves (ESV's) are designed to provide rapid and positive shutdown of gas lines should a down stream rupture or piping break occur. Due to the presence of a built-in fusible element at the valve operating hub the ESV will automatically close when exposed to heat between 212° F. - 250° F. These valves are ideally suited for installation at bulkheads or inline plumbing for automatic emergency shutdown as a result of fire or to provide immediate and positive manual or remote shutdown.

Emergency Shutoff Valve Features

- Powder coated ductile iron body for maximum durability
- Integral swing away check valve with soft seat to promote maximum product flow and minimize product loss in the event of a line failure
- All stainless steel internal component construction provides maximum corrosion resistance
- Flanged end connection for ease of field service
- UL LISTED for use with LP Gas and Anhydrous Ammonia - 400 PSI WOG
- Integral fusible element for automatic closure when exposed to fire
- Durable Teflon® packing gland and resilient seals provide long lasting service life
- Available with pneumatic or cable style latch mechanism



ME980-10



ME980-16-2F



ME980-24



Emergency Shut Off Valves (ESV's)					
Part No.	Description	Latch Type	Material	Flange Material	OAL
ME980-10	1-1/4" FNPT Emergency Shutoff Valve (ESV)	Pneumatic	Ductile Iron	Ductile Iron	5-3/8"
ME980C-10	1-1/4" FNPT Emergency Shutoff Valve (ESV)	Cable	Ductile Iron	Ductile Iron	5-3/8"
ME980-16	2" FNPT Emergency Shutoff Valve (ESV)	Pneumatic	Ductile Iron	Cast Steel	6-7/8"
ME980C-16	2" FNPT Emergency Shutoff Valve (ESV)	Cable	Ductile Iron	Cast Steel	6-7/8"
ME980-24	3" FNPT Emergency Shutoff Valve (ESV)	Pneumatic	Ductile Iron	Ductile Iron	9-5/8"
ME980C-24	3" FNPT Emergency Shutoff Valve (ESV)	Cable	Ductile Iron	Ductile Iron	9-5/8"
ME980-16-2F	2" - 300 lb. Flange Emergency Shutoff Valve (ESV)	Pneumatic	Ductile Iron	Ductile Iron	11-7/8"
ME980C-16-2F	2" - 300 lb. Flange Emergency Shutoff Valve (ESV)	Cable	Ductile Iron	Ductile Iron	11-7/8"
ME980-24-3F	3" - 300 lb. Flange Emergency Shutoff Valve (ESV)	Pneumatic	Ductile Iron	Ductile Iron	14-1/8"
ME980C-24-3F	3" - 300 lb. Flange Emergency Shutoff Valve (ESV)	Cable	Ductile Iron	Ductile Iron	14-1/8"
ME980-24-4F	4" - 300 lb. Flange Emergency Shutoff Valve (ESV)	Pneumatic	Ductile Iron	Ductile Iron	14-1/4"
ME980C-24-4F	4" - 300 lb. Flange Emergency Shutoff Valve (ESV)	Cable	Ductile Iron	Ductile Iron	14-1/4"

To order ESV with Pneumatic Actuator add "A" after the prefix part number i.e. ME980A-10
 To order ESV with Rotary Actuator add "AR" after the prefix part number i.e. ME980AR-10



1-1/4" - 3" Flow Indicating Swing Check Valves

Promotes maximum pump efficiency by providing system operators with a visual inspection point for monitoring liquid flow conditions as well as providing a soft seat back check valve to prevent reverse product flow. Installation of a flow indicating swing check valve upstream of the pump allows the operator to observe product flow and make pump adjustments for maximum flow without cavitation. Suitable for stationary and mobile applications.



ME981-10



ME982-10

Flow Indicating Swing Check Valve Features

- Powder coated ductile iron body for maximum durability
- Removable flanged ends for ease of field service
- Integral swing away check valve with soft seat to promote maximum product flow and prevent reverse product flow
- All stainless steel internal component construction provides maximum corrosion resistance
- Magnetically coupled flow indicator for maximum protection against leaks and minimal resistance to product flow
- Clear/Easy to read flow indicator with "Glow" arrow allows the operator to easily see if the valve is open or closed
- UL LISTED for use with LP Gas and Anhydrous Ammonia - 400 PSI WOG

Part No.	Description	Material	Flange Material	OAL
ME981-10	1-1/4" FNPT Flow Indicating Check Valve	Ductile Iron	Ductile Iron	5-3/8"
ME981-16	2" FNPT Flow Indicating Check Valve	Ductile Iron	Cast Steel	6-7/8"
ME981-24	3" FNPT Flow Indicating Check Valve	Ductile Iron	Ductile Iron	9-5/8"
ME982-10	1-1/4" FNPT Non-Indicating Check Valve	Ductile Iron	Ductile Iron	5-3/8"
ME982-16	2" FNPT Non-Indicating Check Valve	Ductile Iron	Cast Steel	6-7/8"
ME982-24	3" FNPT Non-Indicating Check Valve	Ductile Iron	Ductile Iron	9-5/8"
ME981-16-2F	2" - 300 lb. Flange Flow Indicating Check Valve	Ductile Iron	Ductile Iron	11-7/8"
ME981-24-3F	3" - 300 lb. Flange Flow Indicating Check Valve	Ductile Iron	Ductile Iron	14-1/8"
ME981-24-4F	4" - 300 lb. Flange Flow Indicating Check Valve	Ductile Iron	Ductile Iron	14-1/4"
ME982-16-2F	2" - 300 lb. Flange Flow Non-Indicating Check Valve	Ductile Iron	Ductile Iron	11-7/8"
ME982-24-3F	3" - 300 lb. Flange Flow Non-Indicating Check Valve	Ductile Iron	Ductile Iron	14-1/8"
ME982-24-4F	4" - 300 lb. Flange Flow Non-Indicating Check Valve	Ductile Iron	Ductile Iron	14-1/4"

MEC Excelerator™ High Flow Railcar ESV

Excelerator Railcar Emergency Shutoff Valves (ESV's) are designed to provide rapid and positive shutdown of gas lines should a downstream rupture or piping break occur during product transfer. Featuring a built-in fusible element at the valve operating hub to ensure the ESV will automatically close when exposed to heat between 212° F. - 250° F. In addition to the fusible element, the Excelerator Railcar ESV's are equipped with a poppet design similar the MEC internal safety valves that provides an integral excess flow feature. MEC offers a variety of closing flow values ranging from very high liquid flow rates to more moderate vapor flow rates depending on the application. MEC Excelerator Railcar ESV's are equipped standard with quick disconnect internal pneumatic operators for rapid and reliable open/close of the poppet allowing for convenient on site or remote shutdown of the valve.

Excelerator Railcar Emergency Shutoff Valve Features

- 316 Stainless Steel Body
- All stainless steel internal component construction provides maximum corrosion resistance
- Hardened stainless steel flanged end connection for durability and ease of field service
- UL Listed for use with LP Gas and Anhydrous Ammonia - 400 PSI WOG
- Integral fusible element for automatic closure when exposed to fire
- Durable PTFE packing gland with resilient seals providing long lasting service life
- 100% field repairable - no special tools required
- E-Z grip ribs for installation even with heavy protective hand wear



Part No.	Description	Closing Flow GPM/LPG
ME983-16/150	High Flow Railcar ESV 2" FNPT X 2" FNPT	150*
ME983-16/250	High Flow Railcar ESV 2" FNPT X 2" FNPT	250
ME983-16/500	High Flow Railcar ESV 2" FNPT X 2" FNPT	500
ME983-16	High Flow Railcar ESV 2" FNPT X 2" FNPT	~

* Recommended for vapor service - approx. closing flow 71,000 SCFH/LPG
 ~ Available with Kalrez, Viton and Neoprene seal materials
 ~ For NH3 multiply GPM by .90



ME983 Series

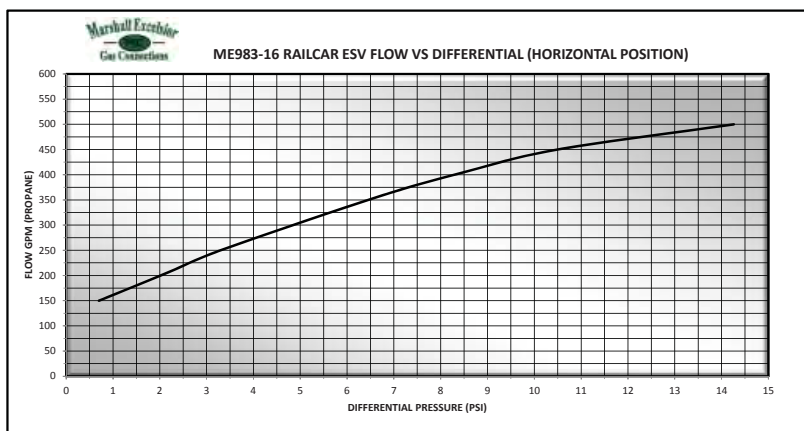

Pressure Relief Valve Warning

INSPECTION

A pressure relief valve discharges when some extraordinary circumstance causes an over pressure condition in the container. If a pressure relief valve is known to have discharged, the relief valve, as well as the entire system, should be immediately and thoroughly inspected to determine the reason for the discharge. In the case of discharge due to fire, the valve should be removed from service and replaced.

Relief valves should be inspected each time the container is filled but no less than once a year. If there is any doubt about the condition of the valve, it must be replaced.

WARNING: *Eye protection must be worn when performing inspection on relief valves under pressure. Never look directly into a relief valve under pressure or place any part of your body where the relief valve discharge could impact it. In some cases a flashlight and small mirror are suggested to assist when making visual inspections.*

In the case of a pressure relief valve that has opened due to a pressure beyond its start-to-discharge setting, the chances of foreign material lodging between the seat and the disc is low, however the possibility is always present. If the relief valve continues to leak at pressure below its start-to-discharge setting it must be replaced.

If there is any doubt about the condition of the relief valve, or if the relief valve has not been protected by a cap for some time, it should be replaced before refilling the container.

Inspection Checklist:

1. **Cap:** Check that the protective cap is in place over the valve or pipeaway stack outlet and has a snug fit. The protective cap helps protect the relief valve against possible malfunction caused by rain, sleet, snow, ice, sand, dirt, pebbles, insects, other debris and contamination. Replace damaged or missing caps at once and keep a cap in place at all times.
2. **Weep Holes:** Inspect and clear debris from the relief valve weep holes. Dirt, ice, paint, and other foreign particles can prevent proper drainage from the valve body. If the weep holes cannot be cleared, replace the valve.

OPERATION OF PRESSURE RELIEF VALVES

Pressure relief valves are set and sealed by the manufacturer to function at a specific "start-to-discharge" pressure in accordance with UL 132. This set pressure is marked on the relief valve and depends on the design requirement of the container to be protected by the relief valve. If the container pressure reaches the start-to-discharge pressure, the relief valve will open a slight amount as the seat disc begins to move slightly away from the seat. If the pressure continues to rise despite the initial discharge through the relief valve, the seat disc will move to a full open position with a sudden "pop". This popping sound is from which the term "pop-action" is derived.

Whether the relief valve opens a slight amount or pops wide open, it will start to close if the pressure in the container diminishes. After the pressure has decreased sufficiently, the relief valve spring will force the seat disc against the seat tightly enough to prevent any further escape of product. The pressure at which the valve closes tightly is referred to as the "re-seal" or "blow-down" pressure. Generally, the re-seal pressure will be lower than the start-to-discharge pressure.

Requirements for Pressure Relief Valves

Every container used for storing or hauling LP-Gas and NH₃ must be protected by a pressure relief valve. These valves are designed to protect the container against the development of hazardous conditions which might be created by any of the following:

3. **Relief Valve Spring:** Exposure to high concentrations of water, salt, industrial pollutants, chemicals and contaminants could cause metal parts to fail including the relief valve spring. If the coating on the relief valve spring is cracked or chipped, replace the valve.
4. **Physical Damage:** Ice accumulations and improper installation could cause mechanical damage. If there are any indications of damage, replace the valve.
5. **Tampering or Readjustment:** Pressure relief valves are factory set to discharge at specified pressures. If there are any indications of tampering or readjusting, replace the valve.
6. **Seat Leakage:** Check for leaks in the seating area using Marshall Excelsior leak detector solution. If there is any indication of leakage, replace the valve. Never force a relief valve closed and continue to leave it in service. This could result in damage to the valve and possible rupture of the container or piping on which the valve is installed.
7. **Corrosion:** Replace the valve if there are any signs of corrosion or contamination.
8. **Moisture, Foreign Particles or Contaminants in the Valve:**
Foreign material such as paint, tar or ice in relief valve parts can impair the proper functioning of the valves. Grease placed in the valve body may harden over time or collect contaminants, thereby impairing the proper operation of the relief valve. Do not place grease in the valve body; replace the valve if there are any indications of moisture or foreign matter in the valve.
9. **Corrosion or Leakage at Container Connection:** Check container to valve connection using Marshall Excelsior leak detector solution. Replace the valve if there is any indication of corrosion or leakage at the connection between the valve and container.

CAUTION: Never plug the outlet of a pressure relief valve. Any device used to stop the flow of a properly operating pressure relief valve that is venting an over pressurized container can cause severe consequences.

- High pressures resulting from exposure of the container to excessive external heat.
- High pressures due to the use of incorrect fuel.
- High pressures due to improper purging of the container.

Consult NFPA #58 for LP-Gas and ANSI #K61.1 for NH₃, and/or any applicable local and state regulations governing the application and use of pressure relief valves.

Selection of MEC Pressure Relief Valves for ASME Containers

The rate of discharge required for a given container is determined by the calculation of the surface area of the container as shown in "Chart A" for LP-Gas and "Chart B" for NH₃.

The set pressure of a pressure relief valve depends upon the design pressure of the container. Refer to NFPA #58 "Liquefied Petroleum Gas Code" for more information.

Pressure Relief Valve Warning

Chart A - Minimum Required Rate of Discharge for LP-Gas Pressure Relief Valves Used on ASME Containers

From NFPA Code #58, Table 5.7.2.6 (2014 Edition)

Minimum required rate of discharge in cubic feet per minute of air at 120% of the maximum permitted start-to-discharge pressure relief valves to be used on containers other than those constructed in accordance with Interstate Commerce specification.

Surface Area Sq. Ft.	Flow Rate CFM Air	Surface Area Sq. Ft.	Flow Rate CFM Air	Surface Area Sq. Ft.	Flow Rate CFM Air	Surface Area Sq. Ft.	Flow Rate CFM Air	Surface Area Sq. Ft.	Flow Rate CFM Air	Surface Area Sq. Ft.	Flow Rate CFM Air	Surface Area Sq. Ft.	Flow Rate CFM Air
20 or less	626	85	2050	150	3260	230	4630	360	6690	850	13540	1500	21570
25	751	90	2150	155	3350	240	4800	370	6840	900	14190	1550	22160
30	872	95	2240	160	3440	250	4960	380	7000	950	14830	1600	22740
35	990	100	2340	165	3530	260	5130	390	7150	1000	15470	1650	23320
40	1100	105	2440	170	3620	270	5290	400	7300	1050	16100	1700	23900
45	1220	110	2530	175	3700	280	5450	450	8040	1100	16720	1750	24470
50	1330	115	2630	180	3790	290	5610	500	8760	1150	17350	1800	25050
55	1430	120	2720	185	3880	300	5760	550	9470	1200	17960	1850	25620
60	1540	125	2810	190	3960	310	5920	600	10170	1250	18570	1900	26180
65	1640	130	2900	195	4050	320	6080	650	10860	1300	19180	1950	26750
70	1750	135	2990	200	4130	330	6230	700	11550	1350	19780	2000	27310
75	1850	140	3080	210	4300	340	6390	750	12220	1400	20380		
80	1950	145	3170	220	4470	350	6540	800	12880	1450	20980		

Surface area = Total outside surface area of container in square feet.

When the surface area is not stamped on the name plate or when the marking is not legible, the area can be calculated by using one of the following formulas:

1. Cylindrical container with hemispherical heads. Area (in sq. ft.) = overall length (ft.) x outside diameter (ft.) x 3.1416
2. Cylindrical container with other than hemispherical heads. Area (in sq. ft.) = [overall length (ft.) + .3 outside diameter (ft.)] x outside diameter (ft.) x 3.1416.
3. Spherical container. Area (in sq. ft.) = outside diameter (ft.) squared x 3.1416.

Flow Rate CFM Air = Required flow capacity in cubic feet per minute of air at standard conditions, 60°F. and atmospheric pressure (14.7 psia).

The flow rate discharge may be interpolated for intermediate values of surface

area. For containers with total outside surface area greater than 2000 square feet, the required flow rate can be calculated using the formula. Flow Rate in CFM Air = 53.632 A^{0.82}. Where A = total outside surface area of the container in square feet.

Valves not marked "Air" have rate marking in cubic feet per minute of liquefied petroleum gas. These can be converted to ratings in cubic feet per minute of air by multiplying the liquefied petroleum gas ratings by the factors listed below. Air flow ratings can be converted to ratings in cubic feet per minute of liquefied petroleum gas by dividing the air ratings by the factors listed below.

Air Conversion Factors

Container Type	100	125	150	175	200
Air Conversion Factor	1.162	1.142	1.113	1.078	1.010

Chart B - Minimum Required Rate of Discharge for Anhydrous Ammonia Pressure Relief Valves Used on ASME Containers

From ANSI K61.1-1999, Appendix A

Minimum required rate of discharge in cubic feet per minute of air at 120% of the maximum permitted start-to-discharge pressure for pressure relief valves to be used on containers other than those constructed in accordance with United States Department of Transportation cylinder specifications.

Surface Area Sq. Ft.	Flow Rate CFM Air	Surface Area Sq. Ft.	Flow Rate CFM Air	Surface Area Sq. Ft.	Flow Rate CFM Air	Surface Area Sq. Ft.	Flow Rate CFM Air	Surface Area Sq. Ft.	Flow Rate CFM Air	Surface Area Sq. Ft.	Flow Rate CFM Air	Surface Area Sq. Ft.	Flow Rate CFM Air
20 or less	626	85	2050	150	3260	230	4630	360	6690	850	13540	1500	21570
25	751	90	2150	155	3350	240	4800	370	6840	900	14190	1550	22160
30	872	95	2240	160	3440	250	4960	380	7000	950	14830	1600	22740
35	990	100	2340	165	3530	260	5130	390	7150	1000	15470	1650	23320
40	1100	105	2440	170	3620	270	5290	400	7300	1050	16100	1700	23900
45	1220	110	2530	175	3700	280	5450	450	8040	1100	16720	1750	24470
50	1330	115	2630	180	3790	290	5610	500	8760	1150	17350	1800	25050
55	1430	120	2720	185	3880	300	5760	550	9470	1200	17960	1850	25620
60	1540	125	2810	190	3960	310	5920	600	10170	1250	18570	1900	26180
65	1640	130	2900	195	4050	320	6080	650	10860	1300	19180	1950	26750
70	1750	135	2990	200	4130	330	6230	700	11550	1350	19780	2000	27310
75	1850	140	3080	210	4300	340	6390	750	12220	1400	20380		
80	1950	145	3170	220	4470	350	6540	800	12880	1450	20980		

Surface area = Total outside surface area of container in square feet.

When the surface area is not stamped on the name plate or when the marking is not legible, the area can be calculated by using one of the following formulas:

1. Cylindrical container with hemispherical heads. Area (in sq. ft.) = overall length (ft.) x outside diameter (ft.) x 3.1416
2. Cylindrical container with other than hemispherical heads. Area (in sq. ft.) = [overall length (ft.) + .3 outside diameter (ft.)] x outside diameter (ft.) x 3.1416.
3. Spherical container. Area (in sq. ft.) = outside diameter (ft.) squared x 3.1416.

Flow Rate CFM Air = Required flow capacity in cubic feet per minute of air at standard conditions, 60°F. and atmospheric pressure (14.7 psia).

The rate of discharge may be interpolated for intermediate values of surface area. For containers with total outside surface area greater than 2,500 square feet, the required flow rate can be calculated using the formula, Flow Rate in CFM Air = 22.11 A^{0.82} where A = outside surface area of the container in square feet.

Conversion Factor

$$\text{ft}^2 \times 0.092 \ 903 = \text{m}^2$$

$$\text{CFM} \times 0.028 \ 317 = \text{m}^3/\text{min}$$

$$\text{ft.} \times 0.304 \ 8 = \text{m}$$



Pressure Relief Valve Warning

INSTALLATION

WARNING: Failure to follow these instructions or to properly install and maintain this equipment could result in an explosion and/or fire causing property damage and personal injury or death. Marshall Excelsior Company equipment must be installed, operated and maintained in accordance with all federal, state and local codes and Marshall Excelsior Company instructions. The installation in most states must also comply with NFPA standards 58 and 59, and ANSI K61.1. Only personnel trained in the proper procedures, codes, standards and regulations of the LP-Gas and NH₃ industries should install, maintain and service this equipment.

Be sure all instructions are read and understood before installation, operation and maintenance. These instructions must be passed along to the end user of the product.

CAUTION: Contact or inhalation of liquid propane, ammonia and their vapors can cause serious injury or death! NH₃ and LP-Gas must be released outdoors in air currents that will insure dispersion to prevent exposure to people and livestock. LP-Gas must be kept far enough from any open flame or other source of ignition to prevent fire or explosion! LP-Gas is heavier than air and will not disperse or evaporate rapidly if released in still air.

Consult NFPA Codes 58 and 59 / ANSI K61.1 and/or any applicable regulations governing the application and use of pressure relief valves. Make sure you are thoroughly trained before you attempt any valve installation, inspection or maintenance.

Proper installation is essential to the safe operation of pressure relief valves. Install MEC pressure relief valves using the following steps:

1. Check that the valve is clean and free of foreign material in the valve inlet and outlet.
2. Verify that the relief valve start-to-discharge setting and flow rate is correct for the application.
3. Apply a suitable PTFE thread sealant compound to the external NPT threads.
4. Inspect the relief valve inlet and valve seat to ensure no thread sealant or foreign material is present.
5. Install relief valve into container port or manifold using appropriate wrench until leak tight joint is achieved.
6. Check for damage and proper operation after valve installation.
7. After the container is charged with product, check joints for leakage using Marshall Excelsior leak detector.
8. After installation is complete, replace protective cap onto relief valve.

Pipeways and deflectors may be required by local codes, laws and regulations depending on the installation. Use only MEC adapters on MEC relief valves. Adapters not designed specifically for piping away MEC relief valves, such as those with 90° turns will reduce internal diameters, and decrease flow dramatically. These should never be used as they can cause the relief valve to chatter and eventually destroy itself.

The addition of deflectors, pipeway adapters and piping will restrict the flow. To properly protect any container, the total system flow must be sufficient to relieve pressure at the pressure setting of the relief valve in accordance with all applicable codes.

RELIEF VALVE SAFETY INFORMATION

Repair and Testing: MEC Pressure Relief Valves are tested and listed by Underwriters Laboratories, Inc., in accordance with UL 132 and NFPA Code #58. Construction and performance of MEC Pressure Relief Valves are consistently checked at the factory by UL and ASME audits. Therefore, testing of MEC Pressure Relief Valves in the field is not necessary.

Any pressure relief valves which shows evidence of leakage, other improper operation or is suspect as to its performance must be replaced immediately using approved procedures.

PIPEWAY ADAPTERS: Pipeway adapters are available for most MEC Pressure Relief Valves, where it is required or desirable to pipe the discharge above or away from the container. Each adapter is designed to sever if excessive stress is applied to the vent piping—thus leaving the relief valve intact and fully operative.

REPLACEMENT OF PRESSURE RELIEF VALVES

WARNING: Under normal conditions, the useful safe service life of a pressure relief valve is 10 years from the original date of manufacture. However, the safe useful life of the valve may be shortened and replacement required in less than 10 years depending on the environment in which the valve lives. Inspection and maintenance of pressure relief valves is very important. Failure to properly inspect and maintain pressure relief valves could result in personal injuries or property damage.

The safe useful life of pressure relief valves can vary greatly depending on the environment in which they live.

Relief valves are required to function under widely varying conditions. Corrosion, aging of the resilient seat disc and friction all proceed at different rates depending upon the nature of the specific environment and application. Gas impurities, product misuse and improper installations can shorten the safe life of a relief valve. The LP-Gas dealer must observe and determine the safe useful life of relief valves in his systems.

For Additional Information Read:

1. NFPA # 58, "Storage and Handling of Liquefied Petroleum Gases".
2. NFPA # 59, "LP-Gases and Utility Gas Plants"

Relief valves in service beyond their service life can exhibit the following degradation in function:

- They may leak at pressures below the set pressure.
- They may open and fail to properly reseal.
- They may open at higher than set pressure.

These failures to function properly are due primarily to four "environmental" conditions:

1. Corrosion of metal parts (particularly springs) which result in the component parts failing to perform.
2. Deterioration of synthetic rubber seat disc material.
3. Clogging or "cementing" of the movable relief valve components so that their movement is restricted.
4. Debris on the valve seat after the relief valve opens, effectively preventing the valve from resealing.

Corrosion is caused by water, corrosive atmospheres of salt and high industrial pollutants, chemicals, and contaminants. High concentrations can attack the metal parts vigorously. No suitable metals are totally resistant to such corrosion.

Synthetic rubber and seat disc materials can also be attacked by impurities in the gas and corrosive atmospheres, particularly those with sulphur dioxide. There are no suitable rubber materials which resist all contaminants.

"Cementing" of relief valve parts can be caused by normal industrial atmospheres containing particles of dirt, iron oxide, metal chips, etc. combined with water, oil, or grease. Ice collecting in recessed valves could cause failure to open. Paint and tar in relief valves also cause failure to function properly.

While the functioning of a pressure relief valve appears to be relatively simple, the assembly and test procedure used to manufacture these MEC products is rather complex. Highly specialized test fixtures and specially trained personnel are necessary to attain proper relief valve settings. These fixtures and personnel are available only at the factory.

WARNING: Never attempt to repair or change the setting of MEC Pressure Relief Valves. Any changes in settings or repairs in the field will void the MEC warranty and product listings, and may create a serious hazard.

Quad-Port Relief Valve Manifold

Designed for use with large LP-Gas and NH₃ stationary storage containers with flanged openings. These relief manifolds have an additional relief valve excluded from the flow rating, which allows for service and/or exchange of any one relief valve without evacuating the tank. Our large port selection handle allows for each specific valve port to be closed off so that the relief valve may be removed while the remaining valves remain under pressure protecting the tank and contents. Each manifold model is rated based on the flow through the relief valves with one valve removed from service.

External Pressure Relief Valve Features

- Heavy duty ductile iron body
- Durable V-cup Teflon® packing stem seals
- Molded rubber weather guard for manifold rotary gear with port plug
- Integral breakaway feature leaves seat and seal intact
- Weep hole deflector and hex socket plugs supplied
- Integrated pilot equalizing feature
- Corrosion resistant finish
- Convenient lifting chain included
- 3-1/2"-8 outlet thread accepts 3" MNPT pipeaway



Large port handle & easy to read port indicators

Part No.	Flange Size	No. of Relief Valves	Application	Flow Capacity SCFM/Air** UL @ 120% Set Pressure	Factory Installed Relief Valve			Accessory 8 Stud / Nut Universal Mounting Kit
					Seal Material*	Start-to-Discharge Setting PSIG	Part No.	
ME903S-3F/250VM	3" - 300# **	3	LPG	20,400 (2)	Viton®	250	MEV250VM/250	ME904SK
ME903S-3F/250CN	3" - 300# **	3	LPG & NH ₃	20,400 (2)	Nitrile	250	MEV250CN/250	ME904SK
ME903S-4F/250VM	4" - 300#	3	LPG	20,400 (2)	Viton®	250	MEV250VM/250	ME904SK
ME903S-4F/250CN	4" - 300#	3	LPG & NH ₃	20,400 (2)	Nitrile	250	MEV250CN/250	ME904SK
ME904S-3F/250VM	3" - 300# **	4	LPG	27,740 (3)	Viton®	250	MEV250VM/250	ME904SK
ME904S-3F/250CN	3" - 300# **	4	LPG & NH ₃	27,740 (3)	Nitrile	250	MEV250CN/250	ME904SK
ME904S-4F/250VM	4" - 300#	4	LPG	27,740 (3)	Viton®	250	MEV250VM/250	ME904SK
ME904S-4F/250CN	4" - 300#	4	LPG & NH ₃	27,740 (3)	Nitrile	250	MEV250CN/250	ME904SK
ME903S-3F/265VM	3" - 300# **	3	LPG	20,555 (2)	Viton®	265	MEV250VM/265	ME904SK
ME903S-3F/265CN	3" - 300# **	3	LPG & NH ₃	20,555 (2)	Nitrile	265	MEV250CN/265	ME904SK
ME903S-4F/265VM	4" - 300#	3	LPG	20,555 (2)	Viton®	265	MEV250VM/265	ME904SK
ME903S-4F/265CN	4" - 300#	3	LPG & NH ₃	20,555 (2)	Nitrile	265	MEV250CN/265	ME904SK
ME904S-3F/265VM	3" - 300# **	4	LPG	28,550 (3)	Viton®	265	MEV250VM/265	ME904SK
ME904S-3F/265CN	3" - 300# **	4	LPG & NH ₃	28,550 (3)	Nitrile	265	MEV250CN/265	ME904SK
ME904S-4F/265VM	4" - 300#	4	LPG	28,550 (3)	Viton®	265	MEV250VM/265	ME904SK
ME904S-4F/265CN	4" - 300#	4	LPG & NH ₃	28,550 (3)	Nitrile	265	MEV250CN/265	ME904SK

* Nitrile not UL Listed

** For use with modified 300 # ANSI Flange with 4" port

*** Flow rating based on number of valves indicated in parenthesis ()

Flow rates are shown as bare relief valves, pipeaways will reduce flow

Teflon® is a trademark of DuPont Company and Viton® is a trademark of DuPont Performance Elastomers.



External Pressure Relief Valves

Designed for installation in stationary ASME applications such as bulk plant, skid tanks, underground and above ground containers, as the primary pressure relief valve.

Note: This valve and all working parts are to be installed outside the container. Therefore, to ensure proper operation of the valve, the valve must be protected from damage and inspections performed as prescribed by Marshall Excelsior.

Steel External Pressure Relief Valve Features

- All stainless steel internal components
- Integral breakaway feature leaves seat and seal intact
- Durable ductile iron hex base
- Weep hole deflector and hex socket plugs supplied
- Corrosion resistant finish
- 3-1/2"-8 outlet thread accepts 3" MNPT pipeaway
- Compatible with **ALL** 2-1/2" FNPT multiple head units

Brass External Pressure Relief Valve Features

- Compact design to fit any application
- Stainless steel spring
- Non-adjustable, tamper resistant design
- Specially designed internal components to increase flow at discharge



MEV250VM/250



MEP250



MEP170



MEV50/250



Part No.	Container Connection	Seal Material*	Start-to-Discharge Setting PSIG	OAL	Wrench Hex	Flow Capacity SCFM/Air** UL @ 120% Set Pressure	Suitable for Tanks w/Surface Area Up To:***	Application	Accessories
MEV25/60	1/4" MNPT	Nitrile	60	1-59/64"	7/8"	—	—	LPG	MEP173 Pipeaway Adapter
MEV25/250	1/4" MNPT	Nitrile	250	1-59/64"	7/8"	—	—	LPG	
MEV25/312	1/4" MNPT	Nitrile	312	1-59/64"	7/8"	—	—	LPG	
MEV25/375	1/4" MNPT	Nitrile	375	1-59/64"	7/8"	—	—	LPG	
MEV50/250	1/2" MNPT	Nitrile	250	2-1/2"	1-1/8"	200	—	LPG	MEP174 Pipeaway Adapter
MEV50/375	1/2" MNPT	Nitrile	375	2-1/2"	1-1/8"	—	—	LPG	
MEV75/250	3/4" MNPT	Nitrile	250	2-21/32"	1-1/8"	—	—	LPG	
MEV75/312	3/4" MNPT	Nitrile	312	2-21/32"	1-1/8"	—	—	LPG	
MEV75/375	3/4" MNPT	Nitrile	375	2-21/32"	1-1/8"	—	—	LPG	MEP170 Relief Valve Adapter MEP250 Installation & Removal Tool
MEV250VM/250	2-1/2" MNPT	Viton®	250	10-1/2"	4-1/8"	10,333	610 Sq Ft.	LPG	
MEV250CN/250	2-1/2" MNPT	Nitrile	250	10-1/2"	4-1/8"	10,333	610 Sq Ft.	LPG & NH ₃	
MEV250VM/265	2-1/2" MNPT	Viton®	265	10-1/2"	4-1/8"	10,948	655 Sq Ft.	LPG	
MEV250CN/265	2-1/2" MNPT	Nitrile	265	10-1/2"	4-1/8"	10,948	655 Sq Ft.	LPG & NH ₃	

Note: Kalrez option available

* Nitrile and Kalrez® not UL Listed

** Flow rates are shown for bare relief valves, pipeaways will reduce flow

*** Per NFPA 58, table 5.7.2.5 area shown is for UL or ASME flow rating, which ever is greater

Viton® and Kalrez® are trademarks of DuPont Performance Elastomers.

Full Internal Pressure Relief Valve

Designed for use on forklift cylinders and other DOT removable cylinders up to 122 pounds of LP-Gas capacity. The working components of this valve are located inside the tank reducing possible malfunction caused by outside debris or other foreign materials.

Note: NFPA #58 states, "All containers used in industrial trucks (including fork lift truck cylinders) service shall have the container pressure relief valve replaced by a new or unused valve within 12 years of the date of manufacture of the container and every 10 years thereafter."

Full Internal Pressure Relief Valve Features

- Stainless steel spring
- Non-adjustable, tamper resistance design
- 45 and 90 degree discharge vents available



MEP175C



MEV75FIR



MEP175-90



MEP175-45

Part No.	Container Type	Container Connection	Seal Material*	Start-to-Discharge Setting PSIG	UL Flow Capacity SCFM/ Air** Per CGA S1.1 @ 480 PSIG	Application	Accessories			
							Protective Cap	Relief Valve Plug	Discharge Vents	
									45° Angle	90° Angle
MEV75FIR*	DOT	3/4" MNPT	Viton®	375	368	LPG	MEP175C	MEP175P	MEP175-45	MEP175-90

* UL Listed in accordance with Compressed Gas Association Pamphlet S-1.1, Pressure Device Standard for Cylinders; Meets requirements for use on DOT containers with 242 lbs. or less weight of water or 122 lbs or less of LP-Gas
 ** Flow rates are shown for bare relief valves, pipeaways will reduce flow

Viton® is a trademark of DuPont Performance Elastomers.

Underground Tank Cluster Valve Removal Tool

Universal design for convenient removal of underground tank cluster valves using a standard 3/4" drive socket wrench.

Underground Tank Cluster Removal Tool Features

- Durable cast steel construction
- Powder coat finish for maximum corrosion protection
- 3/4" drive



MEP126

Part No.	Description
MEP126	Underground Tank Cluster Valve Removal Tool



Full Internal Pressure Relief Valves

Designed for use in mobile LPG & NH₃ containers as a primary pressure relief valve for bobtail and transport trailer installations. All working components are internal to the container connection preventing damage to the valve should a roll-over occur.

Full Internal Pressure Relief Valve Features

- Durable stainless steel body construction
- All stainless steel internal components for maximum corrosion resistance
- Available with Nitrile, Viton®, or Kalrez® valve seals
- Large seating surface for superior seal performance & reliability.
- Available with 250 & 265 PSI  LISTED set pressures
- Custom set pressures available

MEV200FIR/ MEV300FIR



Travel stop prevents damage to relief valve seat



MEP200FIR/MEP300FIR
Hex Installation Tool

Part No.	STD/ PSIG	Container Connection	Installation Hex	Flow Capacity SCFM/Air***	Service		Seat Material	Accessories	
				UL @ 120% Set Pressure	LPG	NH ₃		Cap	Hex Installation Tool
MEV200FIR/250	250	2"MNPT	1-1/2"	4,460	Yes	Yes	Nitrile	MEV200FIR-09	MEP200FIR
MEV200FIR/265	265	2"MNPT	1-1/2"	4,670	Yes	Yes	Nitrile	MEV200FIR-09	MEP200FIR
MEV200FIRV/250	250	2"MNPT	1-1/2"	4,460	Yes	No	Viton®	MEV200FIR-09	MEP200FIR
MEV200FIRV/265	265	2"MNPT	1-1/2"	4,670	Yes	No	Viton®	MEV200FIR-09	MEP200FIR
MEV200FIRK/250*	250	2"MNPT	1-1/2"	4,460	Yes	Yes	Kalrez® ~	MEV200FIR-09	MEP200FIR
MEV200FIRK/265*	265	2"MNPT	1-1/2"	4,670	Yes	Yes	Kalrez® ~	MEV200FIR-09	MEP200FIR
MEV300FIR/250	250	3" MNPT	2-1/2"	10,865	Yes	Yes	Nitrile	MEV300FIR-09	MEP300FIR
MEV300FIR/265	265	3" MNPT	2-1/2"	11,600	Yes	Yes	Nitrile	MEV300FIR-09	MEP300FIR
MEV300FIRV/250	250	3" MNPT	2-1/2"	10,865	Yes	No	Viton®	MEV300FIR-09	MEP300FIR
MEV300FIRV/265	265	3" MNPT	2-1/2"	11,600	Yes	No	Viton®	MEV300FIR-09	MEP300FIR
MEV300FIRK/250*	250	3" MNPT	2-1/2"	10,865	Yes	Yes	Kalrez® ~	MEV300FIR-09	MEP300FIR
MEV300FIRK/265*	265	3" MNPT	2-1/2"	11,600	Yes	Yes	Kalrez® ~	MEV300FIR-09	MEP300FIR

* Seat Material not UL Listed
 ** Flow rates are shown for bare relief valves, pipe-aways will reduce flow
 *** Size relief capacity per NFPA 58 2011, table 5.7.2.6
 ~ Recommended for LPG and NH₃ Dual Service Applications

Viton® and Kalrez® are trademarks of DuPont Performance Elastomers.



Flanged Full Internal Pressure Relief Valves

Designed for use in mobile LPG & NH₃ containers as a primary pressure relief valve for bobtail and transport trailer installations. All working components are internal to the container connection preventing damage to the valve should a roll-over incident occur. Our unique design incorporates a standard 3" ANSI - 300LB. raised face flange connection to assure a 100% leak free connection for rugged over the road applications. This eliminates problems associated with NPT threaded connections and/or tank coupling wear due to vibration caused by over the road transit, providing maximum tank and relief valve service life.



MEV300FIR-3F

Flanged Full Internal Pressure Relief Valve Features

- Durable single piece stainless steel flanged body construction.
- All stainless steel internal components for maximum corrosion resistance.
- Available with Nitrile, Viton®, or Kalrez® valve seals.
- Large seating surface for superior seal performance & reliability.
- Available with 250 & 265 PSI  LISTED set pressures.
- Custom set pressures available

Part No.	STD/ PSIG	Container Connection	Flow Capacity SCFM/Air**	Service		Seat Material	Accessories
				LPG	NH ₃		Cap
MEV300FIR-3F/250	250	3" 300LB. Flange	10,865	Yes	Yes	Nitrile	MEV300FIR-09
MEV300FIR-3F/265	265	3" 300LB. Flange	11,600	Yes	Yes	Nitrile	
MEV300FIRV-3F/250	250	3" 300LB. Flange	10,865	Yes	No	Viton®	
MEV300FIRV-3F/265	265	3" 300LB. Flange	11,600	Yes	No	Viton®	
MEV300FIRK-3F/250*	250	3" 300LB. Flange	10,865	Yes	Yes	Kalrez® ~	
MEV300FIRK-3F/265*	265	3" 300LB. Flange	11,600	Yes	Yes	Kalrez® ~	

* Seat Material not UL Listed
 ** Flow rates are shown for bare relief valves.
 *** Size relief capacity per NFPA 58 2011, table 5.7.2.6
 ~ Recommended for LPG and NH₃ Dual Service Applications

Viton® and Kalrez® are trademarks of DuPont Performance Elastomers.



Semi Internal Pressure Relief Valves

Designed for use in large stationary LPG containers as a primary pressure relief valve. These pressure relief valves have been specifically designed to provide optimum performance when installed in either a 2" half or full coupling making them perfect for most large stationary tank installations.

Note: Available with all stainless steel components for NH₃ stationary container service applications.

MEV200SIR



Semi Internal Pressure Relief Valve Features

- Durable forged brass body with 3" NPT outlet pipeaway thread
- All steel & stainless steel stem, spring, and valve gasket holder for maximum corrosion resistance
- Available with Nitrile, Viton®, or Kalrez® valve seals
- Large seating surface for superior seal performance & reliability
- Available with 125, 250, 265 PSI  LISTED set pressures
- Custom set pressures available



Part No.	STD/ PSIG	Container Connection	Pipeaway Connection	Installation Hex	Flow Capacity SCFM/Air**	Service		Seat Material	Accessories
					UL @ 120% Set Pressure	LPG	NH ₃		
MEV200SIR/125	125	2"MNPT	3"MNPT	3-1/2"	4,870	Yes	No	Nitrile	MEV200SIR-106 (Cap & Lanyard) MEP104-24 (Pipeaway adapter) see page 81
MEV200SIR/250	250	2"MNPT	3"MNPT	3-1/2"	10,925	Yes	No	Nitrile	
MEV200SIR/265	265	2"MNPT	3"MNPT	3-1/2"	11,475	Yes	No	Nitrile	
MEV200SIRV/125	125	2"MNPT	3"MNPT	3-1/2"	4,870	Yes	No	Viton®	
MEV200SIRV/250	250	2"MNPT	3"MNPT	3-1/2"	10,925	Yes	No	Viton®	
MEV200SIRV/265	265	2"MNPT	3"MNPT	3-1/2"	11,475	Yes	No	Viton®	
MEV200SIRK/125*	125	2" MNPT	3"MNPT	3-1/2"	4,870	Yes	No	Kalrez®	
MEV200SIRK/250*	250	2" MNPT	3"MNPT	3-1/2"	10,925	Yes	No	Kalrez®	
MEV200SIRK/265*	265	2" MNPT	3"MNPT	3-1/2"	11,475	Yes	No	Kalrez®	

* Seat Material not UL Listed
 ** Flow rates are shown as bare relief valves.
 *** Size relief capacity per NFPA 58 2011, table 5.7.2.6

Note: For stainless steel add "S" to part to part number - i.e. MEV200SSIR/265

Viton® and Kalrez® are trademarks of DuPont Performance Elastomers.

Universal Relief Valve Covers

These covers are intended to protect both internal & external relief valves ranging in size from 1/2" to 1-1/4" NPT from moisture and/or other possible contaminants. Using the universal "shower cap" style relief valve covers will allow technicians to carry two sizes that will protect the majority of domestic tank relief valves.

Universal Relief Valve Cover

- Made with durable UV stable yellow vinyl material
- Fits 1/2" to 1-1/4" NPT internal and external relief valves



MEH502



MEH503

Part No.	Description	Material
MEH502	Adjustable Relief Valve Cover 1/2" to 3/4"	Yellow Vinyl
MEH503	Adjustable Relief Valve Cover 3/4" to 1-1/4"	Yellow Vinyl



Hydrostatic Pressure Relief Valves

Designed to protect piping and shutoff valves from over pressure situations where liquid LP-Gas or NH₃ has the potential to be trapped. These relief valves provide pressure relief at or in excess of the stated pressure setting, protecting against line or plumbing system failures.

Note: NFPA #58 states, "Hydrostatic relief valves designed to relieve the hydrostatic pressure that can develop in sections of liquid piping between closed shutoff valves shall have pressure settings not less than 400 psig or more than 500 psig unless installed in systems designed to operate above 350 psig. Hydrostatic relief valves for use in systems designed to operate above 350 psig shall have settings not less than 110 percent or more than 125 percent of the system design pressure."

Hydrostatic Relief Valve Features

- Compact design to fit any application
- Stainless steel spring
- Non-adjustable, tamper resistant design
- Stainless steel models rated for LP-Gas & NH₃
- Specially designed internal components to increase flow at discharge



MEH225SS



MEH25



MEH50



MEH75

Part No.	Body Material	Seal Material	Start-to-Discharge Setting PSIG	Inlet MNPT	A	B	C	D	Accessory
									Pipeaway Adapter
MEH225	Brass	Nitrile	440	1/4"	1-1/16"	13/16"	1/4"	9/16" Hex	—
MEH225SS/350	Stainless Steel	Nitrile	350****	1/4"	1-1/16"	13/16"	1/4"	9/16" Hex	—
MEH225SS/400	Stainless Steel	Nitrile	400	1/4"	1-1/16"	13/16"	1/4"	9/16" Hex	—
MEH225SS	Stainless Steel	Nitrile	440	1/4"	1-1/16"	13/16"	1/4"	9/16" Hex	—
MEH25/450	Brass	Nitrile	450	1/4"	1-59/64"	1-43/64"	1/4"	7/8" Hex	MEP173*
MEH25K/450	Brass	Kalrez®	450	1/4"	1-59/64"	1-43/64"	1/4"	7/8" Hex	MEP173*
MEH25V/450	Brass	Viton®	450	1/4"	1-59/64"	1-43/64"	1/4"	7/8" Hex	MEP173*
MEH50/460	Brass	Nitrile	460	1/2"	2-1/2"	2-1/8"	3/8"	1-1/8" Hex	MEP174**
MEH75/460	Brass	Nitrile	460	3/4"	2-21/32"	2-5/32"	1/2"	1-1/8" Hex	MEP174**
MEJ602H***	Brass	Nitrile	440	1/4"	—	—	—	—	—

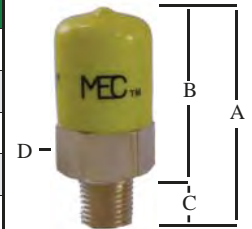

MEP173

* 1/4" FNPT Outlet; ** 1/2" FNPT Outlet; *** Factory Installed Vent Valve, **** Special Applications

Viton® and Kalrez® are trademarks of DuPont Performance Elastomers.

Protective Relief Valve Caps

These protective caps are made of durable, fade resistant vinyl. All relief valves must have a protective cap to keep debris and water out of the valve.



MEH501

Part No.	Cap ID	Cap Height	Replacement Protective Cap for Part No.	Part No.	Cap ID	Cap Height	Replacement Protective Cap for Part No.
MEH501-.437	.437"	3/8"	MEH225 MEH225SS Series	MEH501-1.75	1.75"	1"	—
MEH501-.812	.812"	1"	MEH25/450	MEH501-2.25	2.25"	1"	—
MEH501-1.062	1.062"	3/4"	MEH50/460 MEH75/460	MEH501-2.625	2.625"	1"	—
MEH501-1.5	1.50"	1"	—	MEV250-013*	3.974	1/2"	MEV250 Series

* With Lanyard



Made in the U.S.A.

Vent Valves

Marshall Excelsior is the only manufacturer in the industry that offers three types of vent valves—**Low Emission, Self-Cleaning Low Emission**, and **Standard Vent Valves**. All the vent valves below are designed to minimize loss of product while allowing the operator to effectively bleed down connections and detect liquid levels while filling containers. Vent valves provide an effective means to verify valves have closed in the transfer system when installed into the downstream auxiliary port on the Marshall Excelsior globe and angle valves. Opening the vent valve until liquid or vapor stops venting indicates it is safe to disconnect.

All brass versions have knurled stems that completely unscrew from the valve making the stems replaceable. The stainless steel version has a t-handle stem that is non-removable.

The **Low Emission Vent Valve** and the **Self-Cleaning Low Emission Vent Valve** reduce emissions by **70 Percent** during normal container filling operations. The **Self-Cleaning Low Emission Vent Valve** cleans out the orifice hole each time it is operated. The hole is cleaned out with a #54 orifice drill that reams the valve's orifice hole each time the adjusting screw is loosened or tightened, eliminating nuisance orifice clogging. The reduced venting emissions is achieved by forcing product to pass between the #54 orifice hole and the flutes of the captured self-cleaning apparatus. The self-cleaning replacement screw (MEJ401SC) is compatible with all existing standard vent valve bodies allowing a standard vent valve to be converted into a self-cleaning low emission vent valve without reinstalling the valve body.

The **Standard Vent Valve** has a #54 orifice with no self-cleaning apparatus.

The **Low Emission Vent Valve** has a #72 orifice.

Vent Valve Features

- 70% emission reduction with our Self-Cleaning and Low Emission vent valves
- 1/4" MNPT Connection
- Available with dip tubes. See fixed maximum liquid level gauges

Type	Part No.		
	Brass	Brass Replacement Stems	Stainless Steel*
Low Emission #72 Orifice	MEJ400/72	MEJ401	—
Self-Cleaning Low Emission #54 Orifice	MEJ400SC	MEJ401SC	—
Standard #54 Orifice	MEJ400	MEJ401 MEJ401SC	MEJ402S
Captured Stem Standard #54 Orifice	MEJ400C	—	—
90° Elbow w/ Hydrostatic Relief	MEJ602H***	MEJ400 MEJ401 MEJ401SC	—
90° Elbow 1/4" MPT x 1/4" M. Flare	MEJ606	MEJ400 MEJ401 MEJ401SC	—

* Rated for LP-Gas & NH₃
 ** With Bleeder Valve
 *** Factory Installed Vent Valve



MEJ602H



MEJ400SC
Patented



MEJ400/72



MEJ606



MEJ401



MEJ401SC
Patented



MEJ402S



MEJ400

Fixed Maximum Liquid Level Gauges

Designed to provide a way to visually determine that a tank has reached maximum allowable fill capacity. The dip tube end of a fixed liquid level gauge should be set equal to 80% of the liquid level tank capacity and installed in the vapor space of the tank. The vent valve should be opened before filling begins during which time vapor will be discharged. Once the tank reaches maximum liquid fill capacity (80% of tank capacity), liquid will begin to discharge from the vent valve telling the operator the tank has reached maximum allowable fill capacity and the filling operation should cease immediately.

Marshall Excelsior is the leader in low emission products. For information on the low emission vent valves offered on the fixed liquid level gauges, please visit our vent valve section.

Type	Part No.					
	5.4" Tube Length Brass	5.7" Tube Length Brass	6.6" Tube Length Brass	6.9" Tube Length Brass	12" Tube Length Brass	12" Tube Length Stainless Steel*
Low Emission #72 Orifice	MEJ410/72-5.4	MEJ410/72-5.7	MEJ410/72-6.6	MEJ410/72-6.9	MEJ410/72-120	—
Self-Cleaning Low Emission #54 Orifice	MEJ410SC-5.4	MEJ410SC-5.7	MEJ410SC-6.6	MEJ410SC-6.9	MEJ410SC-120	—
#54 Orifice	MEJ410-5.4	MEJ410-5.7	MEJ410-6.6	MEJ410-6.9	MEJ410-120	MEJ402S-120
Captured Stem #54 Orifice	MEJ410C-5.4	MEJ410C-5.7	MEJ410C-6.6	MEJ410C-6.9	MEJ410C-120	—

* Rated for LP-Gas & NH₃



Y-Strainers

Designed for flow in one direction to guard against debris in pipelines that could cause damage to pumps, valves or other equipment. Can be installed horizontally or vertically. They are available in three stainless steel mesh sizes. The mesh size equals the number of holes per square inch i.e. the smaller the number the larger the holes.

A shutoff valve installed on the filter basket outlet allows for convenient blow-off cleaning of Y-Strainer while under pressure. The ME656S Series Ductile Iron Strainers are available in 3" or 4" -300LB ANSI flange sizes with threaded blow-off ports. All strainers come standard with 40 mesh stainless steel reinforced screens for maximum durability and protection of downstream equipment. Plugs for the threaded blow-offs are available at additional cost.*

Y-Strainer Features

- Durable ductile iron body with automotive grade powder coat finish
- Rated 600 PSI / WOG
- Optional factory installed plug*
- Designed for LP-Gas or NH₃



Part No.			Blow-Off Plug Size	Inlet & Outlet FNPT
20 Mesh Screen	40 Mesh Screen	80 Mesh Screen		
ME650S/20	ME650S	ME650S/80	1/2"	1/2"
ME651S/20	ME651S	ME651S/80	1/2"	3/4"
ME652S/20	ME652S	ME652S/80	3/4"	1"
ME653S/20	ME653S	ME653S/80	3/4"	1-1/4"
—	ME654S	—	1"	1-1/2"
ME655S/20	ME655S	ME655S/80	1"	2"
—	ME656S	ME656S/80	1-1/4"	3"
—	ME656S-3F	—	1-1/4"	3"-300 LB Flange
—	ME656S-4F	—	1-1/4"	4"-300 LB Flange

*To add a factory installed plug use a "P" after the prefix number i.e. ME650SP/20



Pipeaway Adapters

Designed to be installed between semi-internal pressure relief valves and vent stacks or at any point in plant plumbing where breakaway protection is needed. This plated steel adapter has a weak section to help protect the relief valve if vent stack is damaged or to help protect plant plumbing from catastrophic failure.

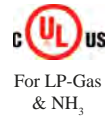

Part No.	Inlet & Outlet	Material
MEP104-24	3" FNPT	Steel

Designed to be installed on the station head or at any point in plant plumbing where breakaway protection is needed. Internal hex broach allows for easy removal from plumbing if broken off.

Part No.	Inlet & Outlet	Material
ME870-6-1	3/4" NPT	Brass
ME870-10-1	1-1/4" NPT	Brass
ME870-16-01	2" NPT	Brass



ME870-16-01

Clamp Style Hose Couplings

These hose couplings are user friendly and can be easily installed in the field. A steel or ductile hose barb is inserted into the hose and two outer clamps, positioned on the outside of the hose, have a boss to keep the bolts from rotating while the clamps compress the hose for a leak free seal.

Note: Clamps must be installed with clamp lip fully engaged into flange groove on hose barb body.

Part No.	Hose Barb	Outlet MNPT
ME3162-08	1/2"	1/2"
ME3162-12	3/4"	3/4"
ME3162-12S	3/4"	1-3/4" F. Acme Steel
ME3162-1216	3/4"	1"
ME3162-16	1"	1"
ME3162-16S	1"	1-3/4" F. Acme Steel
ME3162-1612	1"	1-1/4"
ME3162-2016	1-1/4"	1"
ME3162-20	1-1/4"	1-1/4"
ME3162-2018S	1-1/4"	1-3/4" F. Acme Steel
ME3162-2020S	1-1/4"	2/1/4" F. Acme Steel
ME3162-24	1-1/2"	1-1/2"
ME3162-24S	1-1/2"	1-1/2" F. Acme Steel
ME3162-32	2"	2"
ME3162-32B*	2"	3-1/4" F. Acme Brass
ME3162-32S	2"	3-1/4" F. Acme Steel

* Rated for LP-Gas



ME3162-32B



ME3162-32S



ME3162-20

Clamp Style Hose Coupling Features

- Hose barb constructed of zinc plated steel or ductile iron with automotive grade powder coat finish
- All hose clamps are ductile iron with automotive grade powder coat finish
- Optional integrated female Acme swivel eliminates weight of additional couplings
- Includes hose barb and two clamps, nuts and bolts

Sight Flow Swing Check Valves

Designed with the most durable, impact resistant glass in the industry. This sight flow valve allows bulk plant operators an inspection point to visually monitor liquid flow conditions which allows the operator to achieve maximum pump efficiency. Also features a soft seat swing away check valve which limits flow to one direction. This check valve is usually closed until pressure activates the valve when flow is directed into piping or containers causing the valve to open. When flow stops or reverses, the check returns to the closed position minimizing product loss in the event of a line failure.

Installing a sight flow valve upstream of a plant pump, allows the operator to observe product flow and make pump adjustments for maximum flow without the liquid forming vapor bubbles causing uneven flow patterns and significantly reducing efficiency. Additionally, installing a sight flow valve at the loading arm of a plant allows the operator to maintain consistent observation of pump conditions. This valve is suitable for stationary and mobile applications.

Installing this valve on a compressor operation will provide a visual indication of when the tank car or transport is emptied of liquid and ready for vapor recovery.



Sight Flow Features

- Specially formulated, large diameter impact resistant sight glass with O-ring packing seals for maximum safety and visibility
- Durable ductile iron body with cadmium plated finish
- All steel and stainless steel construction
- Rated up to 400 PSI / WOG
- Hexagon cast ends for ease of installation



Part No.*	Inlet & Outlet FNPT	Seal Material	OAL
ME875S-16	2"	Nitrile	5-3/4"
ME875SN-16	2"	Neoprene	5-3/4"
ME875SV-16	2"	Viton®	5-3/4"
ME875S-24	3"	Nitrile	7-3/8"
ME875SN-24	3"	Neoprene	7-3/8"
ME875SV-24	3"	Viton®	7-3/8"

* "NC" indicates no check e.i. ME875SNC-16

Viton® is a trademark of DuPont Performance Elastomers.

ASME Tank Filler Valves

Designed to allow maximum product transfer with its manually operated open throat design. These valves have an integral high flow primary soft-seat back check and a manually operated secondary shutoff valve for maximum protection against leaks. Because these valves provide a manually operated shutoff device, the need for a flow restricting fill check adapter has been eliminated.



Patent Pending

ASME Tank Filler Valve Features

- Allows **25-50%** more product flow during filling operations
- Manual valve portion assures operator when valve is open or closed
- Removable key provided to help prevent tampering
- Constructed with a durable Nitrile O-ring primary back check seal and reliable Teflon® packing for secondary manual valve seal
- Durable all brass construction for maximum weather and spark resistance

Teflon® is a trademark of DuPont Company

Part No.	Filler Valve MNPT	Hose End M. Acme Connection	Protective Cap Included	Additional Keys
ME600-6*	3/4"	1-3/4"	Yes	ME578-02
ME600-10*	1-1/4"	1-3/4"	Yes	ME578-02
ME601-6	3/4"	1-3/4"	Yes	—
ME601-10	1-1/4"	1-3/4"	Yes	—

*Manual Shutoff



Breakaway Couplings

Designed to provide a safe way to transfer LP-Gas and NH₃ without sacrificing flow. The *FloKill*TM Breakaway Coupling flows both directions and protects against expensive loss of product or equipment damage if a pull-away occurs during a transfer operation. One end of the breakaway coupling should be attached to a fixed or sturdy point. In the event of an excessive amount of pull force, the breakaway coupling will separate and immediately shutoff product flow in both directions.

To reconnect the valve, pressure needs to be relieved from both ends of the line, therefore it is recommended that a safe way to bleed down the line is provided upstream and downstream. After the lines have been depressurized use Marshall Excelsior's re-installation tool (MEP128-6) for 3/4" or slide the male end into the female side and pull the collar back until they lock. After reconnection the line must be tested using Marshall Excelsior Leak Detector to check for leaks before any product is transferred. The breakaway coupling may be used on vapor or liquid lines on transports, delivery trucks, motor fuel containers, fill cabinets and other miscellaneous filling operations.

Note: It is recommended that breakaway couplings be safety tested monthly to confirm that proper separation occurs in the event of a pull-away. Dry air is suggested for a source of pressure during testing.

*FloKill*TM Breakaway Coupling Features

- Nitrile soft seat provides positive shutoff both upstream and downstream of source
- 100—300 lbs of force required for disconnect
- Approximately 100 lbs of force to reconnect
- Large internal bore for increased flow
- Durable plated steel construction
- Rated for LP-Gas & NH₃



ME860S-6

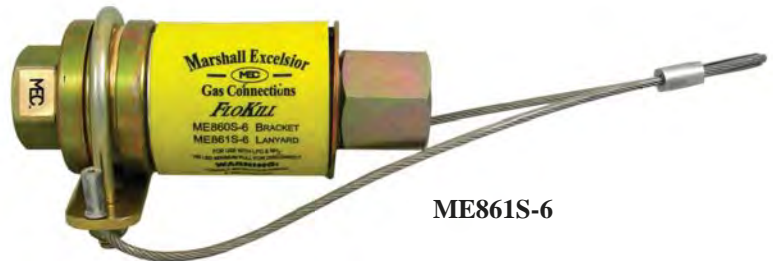

ME861S-6



MEP128-6
Coupling Not Included

Part No.		Connection FNPT	OAL Length	Accessory
Bracket Style	Lanyard Style			Reassembly Tool
ME860S-6	ME861S-6	3/4"	6"	MEP128-6
ME860S-8	ME861S-8	1"	6-3/4"	—
ME860S-10	ME861S-10	1-1/4"	7-3/4"	—

Vapor Service Engine Fuel Valves & Connectors

These CGA 789 quick closing couplings are designed for use with vapor service motor fuel applications. Incorporates **all** the same features as the standard and Moto-Seal motor fuel filler valves and connectors. The left hand Acme thread allows service on outdoor motor fuel propane equipment including lawn mowers, etc.



ME220ML

Moto-Seal Replaceable Tip (ME795-3-02)

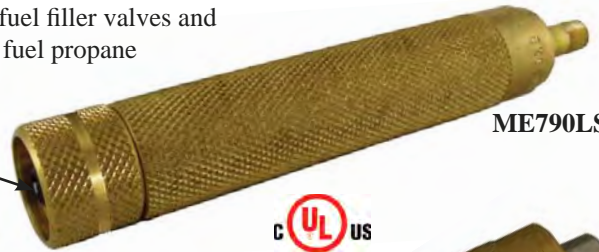

ME790LSN



ME220FLSN

Part No.	Moto-Seal Part No.	Inlet	Outlet	Application	Protective Brass Cap
ME220FL	ME220FLSN	1-1/4" Female Left Hand Acme	1/4" FNPT	Fuel Line	—
ME220ML	—	3/8" FNPT	1-1/4" Male Left Hand Acme	Service Valve	ME220FLP
ME790L	ME790LSN	1-1/4" Female Left Hand Acme	1/4" MNPT	Filler Valve	—

Engine Fuel Bulkheads

These bulkheads provide a stationary point for motor fuel lines to pass thru sections of sheet metal.

Part No.	Connection	Connection
MET443	3/8" Male Flare	1/4" FNPT (2 Ports)
MET444	3/4"-16 Male / 1/4" FNPT	1/4" FNPT (2 Ports)
MET445	3/4"-16 Male / 1/4" FNPT	1/4" FNPT (3 Ports)



MET444



MET443

Carburetion Filter & Fittings

The gas/air filter is used to filter foreign materials and/or particles from LP-Gas systems such as motor fuel/carburetion systems. Also designed to be used to filter air supply lines for internal and emergency shutoff valve actuator systems.



ME709

Enables the installation of a 1/4" MNPT hydrostatic relief valve in a safe, protected area. This two piece carburetion hose fitting fits all stainless steel braided LP-Gas hose with a 5/16" ID. The tank valve side has a 3/8" female flare swivel and zinc plated for maximum corrosion resistance.



ME8346



ME229-EL
90° Angle

Allows connection of a motor fuel service line from 1-3/4" female Acme vapor outlet.

Part No.	Inlet	Outlet	Side Port
ME709	1/4" FNPT	1/4" MNPT	—
ME229-EL	1-3/4" F. Acme	1/2" Male Flare	—
ME8346	5/16" ID	3/8" Female Flare	1/4" FNPT



Filler & Vapor Couplings

These couplings are used as connections between the hose and transfer valve. The filler coupling is designed to provide different connections for the end of a hose (inlet) or an angle, globe or quick acting valve (outlet) when transferring liquid. The vapor coupling is designed to be used with valves having an upper check mechanism. The nose piece on the vapor coupling opens the check valve allowing vapor equalization.

The extended style has a stainless steel female Acme nut insert cast into the heavy duty aluminum handle. All filler and vapor couplings come with a factory installed retaining ring unless noted. The retaining ring limits the travel of the handle or nut during disconnect reducing spin-offs and promoting proper venting of the captured product.



Service Type	Part No.							F. Acme	MNPT
	Brass		Brass Wing Nut/Steel Nipple	Steel*					
	Knurled Nut	Wing Nut		Knurled Nut	Wing Nut	Extended Handle			
					Standard	Fluted			
Liquid	ME100	—	—	—	—	—	—	1-1/4"	3/8"
	ME101	—	—	—	—	—	—	1-1/4"	1/2"
	ME110	ME110C	—	—	—	ME635-4	ME635G-4	1-3/4"	1/2"
	ME111	ME111C	—	ME111S	ME111SC	ME635-6	ME635G-6	1-3/4"	3/4"
	—	—	—	—	ME113SC	—	—	1-3/4"	3/4" FNPT
	ME112	ME112C	—	ME112S	ME112SC	ME635-8	ME635G-8	1-3/4"	1"
	—	—	—	—	—	ME635-10	ME635G-10	1-3/4"	1-1/4"
	—	ME120** ME120WR	ME120S** ME120SWR	—	ME121S** ME121SWR	—	—	2-1/4"	1-1/4"
	—	ME130B** ME130BWR	ME130** ME130A*** ME130WR	—	ME130S** ME130SWR	—	—	3-1/4"	2"
Vapor	ME140	—	—	—	—	—	—	1-1/4"	3/8"
	ME141	—	—	ME141S	—	—	—	1-1/4"	1/2"
	—	—	—	—	—	ME646-4	ME646G-4	1-3/4"	1/2"
	ME150	ME150C	—	ME150S	ME150SC	ME646-6	ME646G-6	1-3/4"	3/4"
	ME151	ME151C	—	ME151S	ME151SC	ME646-8	ME646G-8	1-3/4"	1"
	—	—	—	—	—	ME646-10	ME646G-10	1-3/4"	1-1/4"
	—	—	ME160	—	ME160S	—	—	2-1/4"	1-1/4"



* Rated for LP-Gas & NH₃
 ** Does not include a factory installed retaining ring
 *** Includes factory installed filter screen

Acme Adapters

Part No.			M. Acme	FNPT	MNPT
Brass		Steel*			
No Screen	Factory Installed Screen				
ME498-4/2	—	—	1-1/4"	1/4"	1/2" **
ME498-6/3	—	—	1-1/4"	3/8"	3/4" **
ME192	—	—	1-1/4"	1/2"	—
ME193	—	—	1-1/4"	3/4"	—
ME210	—	—	1-3/4"	1/4"	—
ME211	—	—	1-3/4"	3/8"	—
ME212	—	—	1-3/4"	1/2"	—
ME213	—	ME213S	1-3/4"	3/4"	—
ME214	—	ME214S	1-3/4"	1"	—
ME502-12/8	—	—	2-1/4"	1"	1-1/2" **
ME502-16/10	—	ME502S-16/10	2-1/4"	1-1/4"	2" **
ME502-16/12	—	—	2-1/4"	1-1/2"	2" **
ME250	ME250A	—	3-1/4"	1-1/4"	—
ME251	ME251A	—	3-1/4"	1-1/2"	—
ME252-16	ME252A-16	ME252S-16	3-1/4"	2"	—
ME508-24	ME508A-24	ME508S-24	3-1/4"	3"	—

* Rated for LP-Gas & NH₃
 ** Male Thread Outside & Female Thread Inside



ME192



ME212



ME252S-16



ME503J-16

1/4" FNPT with Vent Valve & #54 Orifice



ME503JB-16

Brass Vent Valve



ME503JS-16

Stainless Steel Vent Valve

Part No.						M. Acme	FNPT/ MNPT
Brass			Steel*				
Factory Machined 1/4" FNPT with Vent Hole	Factory Installed Brass Vent Valve	Factory Installed Stainless Steel Vent Valve	Factory Machined 1/4" FNPT with Vent Hole	Factory Installed Brass Vent Valve	Factory Installed Stainless Steel Vent Valve		
ME252J-16	ME252JB-16	ME252JS-16	ME252SJ-16	ME252SJB-16	ME252SJS-16	3-1/4"	2" FNPT
ME503J-16	ME503JB-16	ME503JS-16	ME503SJ-16	ME503SJB-16	ME503SJS-16	3-1/4"	2" MNPT

To add a factory installed screen use an "A" after the prefix number i.e. ME252AJB-16
 * Rated for LP-Gas & NH₃



Acme Adapters

Part No.			M. Acme	MNPT	FNPT
Brass		Steel *			
No Screen	Factory Installed Screen				
ME498-4/2	—	—	1-1/4"	1/2"	1/4" **
ME498-6/3	—	—	1-1/4"	3/4"	3/8" **
—	—	ME520S-8	1-1/4"	1"	—
—	—	ME521S-4	1-3/4"	1/2"	—
ME215	—	ME215S	1-3/4"	3/4"	—
ME216	—	ME216S	1-3/4"	1"	—
ME217	ME217A	ME217S	1-3/4"	1-1/4"	—
ME233	—	ME233S	2-1/4"	1-1/4"	—
ME502-12/8	—	—	2-1/4"	1-1/2"	1" **
ME502-16/10	—	ME502S-16/10	2-1/4"	2"	1-1/4" **
ME502-16/12	—	—	2-1/4"	2"	1-1/2" **
ME503-16	ME503A-16	ME503S-16	3-1/4"	2"	—
ME503-20	ME503A-20	—	3-1/4"	2-1/2"	—
ME262	ME262A	ME262S	3-1/4"	3"	—

* Rated for LP-Gas & NH₃
 ** Male Thread Outside & Female Thread Inside



ME215S



ME503-16

Acme Adapter with Screen

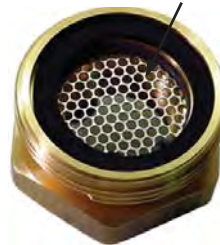

Part No.		M. Acme	Female UNC Thread
Brass	Steel*		
ME209	ME209S	1-3/4"	3/8"-16

To hold hose end valve secure when not in use

* Rated for LP-Gas & NH₃



MEP503



MEP503K Installed
(ME503-16 not included)

Part No.	Description
MEP503	Conical Filter Screen only for 3-1/4" M Acme Adapters 30 Mesh - Stainless Steel
MEP503K	Conical Filter Screen and Retainer for 3-1/4" M Acme Adapters 30 Mesh - Stainless Steel

Part No.		M. Acme	M. Acme
Brass	Steel *		
ME270	—	1-1/4"	1-1/4"
ME273	ME273S	1-3/4"	1-3/4"
ME275	ME275S	2-1/4"	2-1/4"
ME277	ME277S	3-1/4"	3-1/4"

* Rated for LP-Gas & NH₃



Acme Reducer Couplings

ME442



Part No.		F. Acme	M. Acme
Brass	Steel *		
ME611	ME611S	2-1/4"	1-3/4"
ME612	ME612S	3-1/4"	1-3/4"
ME614	ME614S	3-1/4"	2-1/4"
ME442	ME442S	3-1/4"	1-1/4" FNPT

* Rated for LP-Gas & NH₃



ME612S



Acme Caps



ME229-EL
1-3/4" F. Acme x
1/2" Male Flare
90°



ME229



ME441F-1
Chain Included

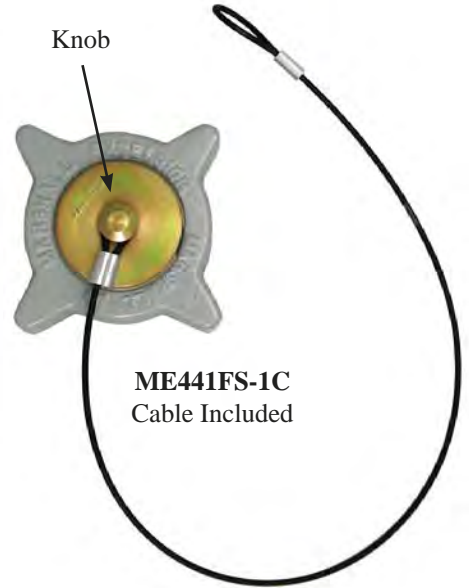

ME441FS-1C
Cable Included



ME441RS

Tapped Hole



Part No.						F. Acme	Style	Accessory	
Brass			Steel *					Chain Only**	Cable Only
Cap Only	Cap with Chain	Cap with Cable	Cap Only	Cap with Chain	Cap with Cable				
ME229	ME229-1	—	ME229S	ME229S-1	—	1-3/4"	Pin Hole	MEP148	—
ME229F	ME229F-1	ME229F-1C	ME229FS	ME229FS-1	ME229FS-1C	1-3/4"	Knob	MEP167	MEP168
ME431F	ME431F-1	—	ME431FS	ME431FS-1	—	2-1/4"	Knob	MEP167	MEP168
ME431R	ME431R-1	—	—	—	—	2-1/4"	Tapped Hole	MEP167	MEP168
ME441F	ME441F-1	ME441F-1C	ME441FS	ME441FS-1	ME441FS-1C	3-1/4"	Knob	MEP167	MEP168
ME441R	ME441R-1	—	ME441RS	ME441RS-1	—	3-1/4"	Tapped Hole	MEP167	MEP168

* Rated for LP-Gas & NH₃
 ** MEP147 ring fits over 3/4" MNPT—MEP148 ring fits over 1-1/4" MNPT
 Note: Red and Yellow versions available upon request



ME106

Part No.		F. Acme	Style	Accessory
Plastic				
Cap Only	Cap with Chain			
ME108	ME108-1	1-1/4"	Pin Hole	MEP147
ME109 or ME109-NH3*	ME109-1 or ME109-NH3-1*	1-3/4"	Pin Hole	MEP148
ME106	ME106-1	3-1/4"	Pin Hole	—

* Rated for NH₃
 ** MEP147 ring fits over 3/4" MNPT—MEP148 ring fits over 1-1/4" MNPT



ME109-NH3



Acme Caps with Flange

The flange allows for easy operation of pneumatic or proximity interlock switches which control the safety systems of transport vehicles. The stainless steel flange is flush mounted to the Acme cap.



ME441F8



Part No.						F. Acme	Style	Flange Diameter	Accessory	
Brass			Steel *						Chain Only	Cable Only
Cap with Flange	Cap with Flange & Chain	Cap with Flange & Cable	Cap with Flange	Cap with Flange & Chain	Cap with Flange & Cable					
ME229F5	ME229F5-1	ME229F5-1C	ME229FS5	ME229FS5-1	ME229FS5-1C	1-3/4"	Knob	5"	MEP167	MEP168
ME441F8	ME441F8-1	ME441F8-1C	ME441FS8	ME441FS8-1	ME441FS8-1C	3-1/4"	Knob	8"	MEP167	MEP168
ME441R8	ME441R8-1	—	—	—	—	3-1/4"	Tapped Hole	8"	MEP167	MEP168

* Rated for LP-Gas & NH₃

Heavy Duty Acme Spanner Wrenches

EZ-Turn Ergonomic Aluminum Acme spanner wrench for 3-1/4" female Acme caps.



MEP120C

Part No.	Length
MEP120C	13-3/4"

Aluminum Acme spanner wrench for 1-3/4", 2-1/4", 3-1/4" and 4-1/4" female Acme caps.

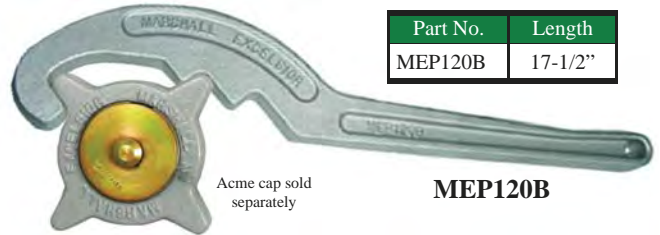

Part No.	Length
MEP120B	17-1/2"

MEP120B

Acme cap sold separately

Acme Dust Plugs

Part No.									M. Acme
Aluminum			Brass			Plastic			
Plug Only	Chain Only*	Plug with Chain	Plug Only	Chain Only*	Plug with Chain	Plug Only	Chain Only*	Plug with Chain	
—	—	—	ME178B	MEP148	ME178B-1	ME178	MEP147	ME178-1	1-1/4"
ME239	MEP148	ME239-1	ME179B	MEP148	ME179B-1	ME179	MEP148	ME179-1	1-3/4"
—	—	—	ME180B	MEP167	ME180B-1	ME180	MEP148	ME180-1	2-1/4"
—	—	—	ME181B	MEP167	ME181B-1	ME181	MEP183	ME181-1	3-1/4"

* MEP147 ring fits over 3/4" MNPT—MEP148 ring fits over 1-1/4" MNPT



ME179

ME181B



Wheel Chock



Designed with a “Double Grip” handle for easy carrying and dual traction grips for the road and tire. The aluminum material makes the wheel chock lightweight and able to withstand the toughest environments. Turn the wheel chock upside down and the points on top of the wheel chock will dig into the snow, ice and mud to prevent sliding. Durable safety yellow powder coat finish.

Part No.	Height	Length	Width
ME200	7”	10”	7”

Wheel Chock Bracket

Designed to provide a durable and convenient receptacle to store wheel chocks during over-the-road transit. Durable aluminum construction and molded inserts prevent damage to wheel chocks. For installations that require additional mounting clearance a standoff extension kit is available.

Part No.	Height	Length	Depth	Wheel Chocks Included	Accessory
					Standoff Extension Kit
ME200B	7-3/4”	20”	7”	No	
ME200BK	9-3/4”	20”	8”	Yes	ME200EXT



ME200BK

Universal Spring Loaded Utility Bracket

Provides a safe and secure method to mount and retain hand tools such as shovels, picks, brooms or other equipment for bobtail or utility vehicles during over the road transit.

Universal Spring Loaded Utility Bracket Features

- Cast aluminum body for maximum durability
- Vinyl coated for maximum security
- All stainless steel spring and mounting hardware

Part No.	Description
MEP082	Universal Spring Loaded Utility Bracket



MEP082



Container Thermometers

Part No.	Dial Diameter	Probe Length
MEJ700	2"	4"
MEJ701	2"	6"
MEJ702	3"	4"
MEJ703	3"	6"



Designed for use in LP-Gas or NH₃ storage tanks, nurse tanks, bottails and transports. These stainless steel, dust and water proof thermometers feature a 1/2" MNPT connection with a temperature range from -40° to +120° Fahrenheit. Accuracy +/- 1 percent full range.

Pressure Gauges

Designed to measure the pressure of gas or liquid. Marshall Excelsior offers two types of gauges, dry and glycerin filled. The dry gauge is the most commonly used and least expensive gauge. With a glycerin filled gauge, the life of the gauge is extended, vibration of the pointer is minimized and condensation, caused by humid air inside the gauge, is eliminated.

To determine the correct gauge, environment along with normal operating system pressure must be considered. The pressure range of the gauge should be twice the normal system pressure to maximize gauge life and accuracy.

Part No.		PSIG	Dial Size	Fill Type
1/4" MNPT Bottom Mount	1/4" MNPT Back Mount			
MEJ520	—	0-5	2-1/2"	Dry
MEJ500	MEJ510	0-15	2"	Dry
MEJ603LP-01*	—	0-15	2-1/2"	Glycerin
MEJ501	MEJ511	0-30	2"	Dry
ME50ECO-2	—	0-30" WC	2-1/2"	Dry
MEJ502	MEJ512	0-60	2"	Dry
MEJ503	MEJ513	0-100	2"	Dry
MEJ504	—	0-160	2"	Dry
MEJ505	—	0-200	2"	Dry
MEJ600-02	MEJ516	0-300	2"	Dry
MEJ603HP-01*	—	0-300	2-1/2"	Glycerin
MEJ580***	—	0-300	4"	Dry
MEJ542**	—	0-400	2-1/2"	Glycerin
—	MEJ524*	0-400	2-1/2"	Glycerin
MEJ552*	MEJ526**	0-400	2-1/2"	Glycerin

* Brass Pipe Thread; Stainless Steel Dial
 ** Stainless Steel Gauge *** Plated Steel Gauge

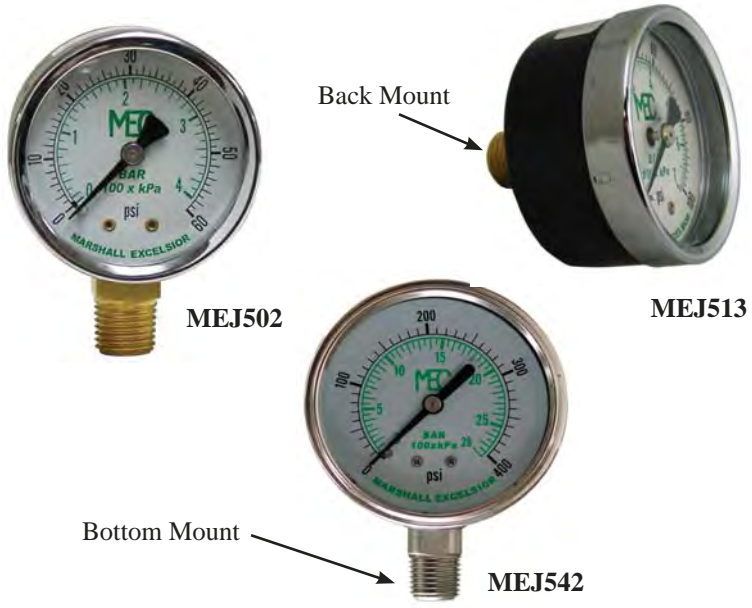

Pressure Gauge Protective Boot

Designed to fit over the pressure gauge dial to extend the life and accuracy of dry and liquid pressure gauges. This boot helps protect the dry pressure gauge's fragile internal components and helps prevent dents on liquid pressure gauges which cause the gauge to leak.

Part No.	Fits
MEJ2.5GB	2-1/2" Dial, Bottom Mount Pressure Gauge

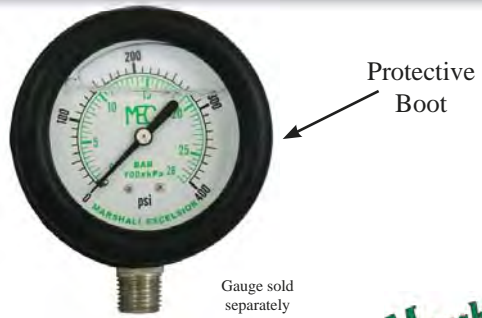

Gauge sold separately



Pressure Gauge Snubbers

Designed for a pressure gauge to be threaded into the outlet of the snubber. The snubber will reduce pressure fluctuations that can over pressurize or damage the gauge while maintaining a quick response time and a steady reading.

Part No.	Material	Style	Inlet (MNPT)	Outlet (FNPT)
ME202	Brass	#54 Orifice	1/4"	1/4"
ME202SS	Stainless Steel	#54 Orifice	1/4"	1/4"
ME204	Brass	Sintered Metal Filter Disc	1/4"	1/4"



ME202SS



ME204

Serviceman's Replacement Seal Kit

Designed to provide a convenient storage system for all common LP-Gas and NH₃ gaskets and O-rings. Perfect for dispenser cabinets or bobtail and transport drivers.

Serviceman's Replacement Seal Kit Features

- Durable ABS plastic container with storage latch
- Preformed insert with individual spaces for each gasket/O-ring size
- Labeled with each gasket/O-ring size and part number for easy identification and reorder purposes
- All gaskets/O-rings manufactured from  approved compounds for LP-Gas and NH₃ services



MEW1

MEW1—Serviceman's Replacement Seal Kit Includes:	Qty	Replacement Part No.
1-1/4" Acme Motor Fuel Flat Gasket	9	MEW4
1-1/4" Acme Flat Gasket	10	MEW3
1-3/4" Acme Flat Gasket	10	MEW2
2-1/4" Acme Flat Gasket	10	MEW5
3-1/4" Acme Flat Gasket	10	MEW6
Male Motor Fuel Connector O-ring	12	ME220M-02
POL O-ring	12	568-110-01



MEW1 Layout



Hose Reel Control Switch Covers

These covers are intended to protect Hannay® Hose Reel Control Switches from moisture and/or other contaminants during over-the-road transit. The MEP-GMC1 is specifically designed to fit Hannay® Guidemaster® control switches while the MEP-RDC1 is specifically designed to fit Hannay® red DOT EPS style control switches. Both of these covers fit snugly over the control to help prevent damage due to moisture or other contaminants thereby increasing the longevity of the control switch.

Switch Cover Features:

- Made with durable UV stable black low temperature EPDM material
- Includes security lanyard to help prevent loss of the cap
- Fits Hannay® Guidemaster® and red DOT EPS switches
- Control switch can be operated through cover without removing

Part No.	Description	Material
MEP-GMC1	Hose Reel Control Switch Cover for Guidemaster® Control Arm	Black EPDM
MEP-RDC1	Hose Reel Control Switch Cover for Red DOT EPS	Black EPDM

* "Hannay®" and "Guidemaster®" are trademarks of Hannay Reels



Needle Valves

Intended for application where precise control of gas output is required. These precision machined valves offer a wide range of adjustment without stem galling. Perfect for isolating pressure gauges from bulk storage containers or upstream shutoff valves for torches and/or outdoor burner applications.

Needle Valve Features:

- Available in brass, plated steel & stainless steel construction
- Tapered valve body seat & stem for precision accuracy
- Various inlet / outlet configurations available
- ME831 & ME834 series valves approved for bi-directional flow

Part No.	Description	Material
ME831	Needle Valve 1/4" MNPT x 1/4" FNPT	Brass
ME832	Needle Valve 1/4" MNPT Outlet x #80 Orifice 1"- 20 F. Inlet	Brass
ME833	Needle Valve 1/4" MNPT Outlet x 1"- 20 F. Inlet	Brass
ME834	Needle Valve 1/4" MNPT x 9/16" -18 LH Male	Brass
ME831S	Needle Valve 1/4" MNPT x 1/4" FNPT	Plated Steel
ME831SS	Needle Valve 1/4" MNPT x 1/4" FNPT	Stainless Steel



ASME/ DOT Container Service Valves

Intended for use in vapor withdrawal service for ASME and DOT containers or as fuel line shutoff valves.

Note: These valves **do not** incorporate an integral pressure relief valve and are intended for use in containers that have a separate stand alone pressure relief valve sized to properly handle the container's capacity.

ASME/ DOT Container Service Valves Features

- One piece forged brass body construction
- Dual O-ring packing design
- Easy to repair / replace bonnet assembly
- Universal bonnet assembly
- Industry best fill flow rate
- Factory applied thread sealant
- Heavy duty replaceable zinc hand wheel



ME9101C1



ME9101D-11.7

Part No.	Description	Dip Tube Length
ME9101C1	3/4" MNPT X F. POL ASME/ DOT Service Valve (No Dip Tube)	N/A
ME9101D-11.1	3/4" MNPT X F. POL ASME/ DOT Service Valve (with Dip Tube)	11.1"
ME9101D-11.7	3/4" MNPT X F. POL ASME/ DOT Service Valve (with Dip Tube)	11.7"



Double Check Fill Valves

Designed for DOT forklift, engine fuel and ASME residential tanks, these double check filler valves automatically open with pump pressure providing maximum product flow rates. Once flow ceases, both upper and lower check mechanisms close to prevent product loss from the container. The lower check serves as a secondary seat to limit product loss in the event that the primary upper seat fails to operate properly due to damage.

Double Check Fill Valve Features

- Industry best flow rate
- Resilient bonded main valve seal
- Integral break away feature leaves primary check intact in the event of delivery truck roll away
- Field repairable upper check seat
- Factory applied thread sealant



ME601-6



ME601-10



Part No.	Description	Flow Rate LPG		Accessories
		10 PSI	20 PSI	Cap & Lanyard
ME601-6	1-3/4" M. Acme x 3/4" MNPT Double Fill Valve w/ Cap & Lanyard	11	24	ME601-902
ME601-10	1-3/4" M. Acme x 1-1/4" MNPT Double Fill Valve w/ Cap & Lanyard	22	36	ME601-902



Forklift Cylinder & Engine Fuel Valves

Intended for vapor or liquid withdrawal service on DOT forklift or engine fuel containers. Two closing flow rates are offered - 1.5 GPM for medium to light duty vehicles and 2.6 GPM for those with greater fuel demands.

Note: These valves **do not** incorporate an integral pressure relief valve and are intended for use in containers that have a separate pressure relief valve to adequately handle the container's capacity. Each of these valves incorporate an excess flow valve at the tanks inlet end to prevent excessive product loss in the event of a downstream fuel line failure. For the excess flow device to perform properly the service valve must be in the full open and back seated position.

Forklift Cylinder & Engine Fuel Valve Features

- One piece forged brass body construction
- Dual O-ring packing design
- Easy to repair / replace bonnet assembly
- Universal bonnet assembly
- Industry best fill flow rate
- Factory applied thread sealant
- Replaceable, heavy duty zinc hand wheel featuring a universal design



Part No.	Description	Excess Flow GPM
ME9101P5	3/4" MNPT X 3/8" MNPT Forklift Service Valve	1.6 GPM
ME9101P5H	3/4" MNPT X 3/8" MNPT Forklift Service Valve	2.6 GPM
ME9101H4	3/4" MNPT X 3/8" M. Flare Motor Fuel Service Valve	1.6 GPM
ME9101H6	3/4" MNPT X 3/8" M. Flare Motor Fuel Service Valve	2.6 GPM
ME9101C5	3/4" MNPT X F. POL ASME/ DOT Container Service Valve	2.6 GPM

This heavy duty designed wrench features a 1/2" drive socket extension for removing and installing motor fuel cylinder valves



Engine Fuel Remote Fill Valve

Specifically designed for remote filling applications where a standard tank type filler valve is not practical. Perfectly suited for motor fuel applications or other hard to reach remote tank applications. This single check fill valve is designed to provide maximum product fill rates along with an automatic shutoff once product flow ceases.

Engine Fuel Remote Fill Valve Features

- Single check design allows maximum product flow rate
- Integral break away feature leaves check valve intact in the event of a vehicle roll away during filling
- Resilient bonded main valve seal
- Rear bulkhead mounting with quarter panel jam nut and lock washer
- Single piece main valve body for maximum strength and durability



Part No.	Description	Accessories
		Cap & Lanyard
ME602-8	1-3/4" M. Acme x 1/2" M. Flare Remote Fill Valve w/ Cap & Lanyard	ME601-902

Engine Fuel Filler Valves & Connectors

The CGA 790 quick closing couplings (ME220 Series) are designed to join the carburetion fuel line to the service valve on motor fuel type applications. The Acme threads allow for quick and repeated removal and connection with minimal product loss. The ME220M connects directly to the service valve outlet, while the ME220F Series connects to the motor fuel line. Both couplings have an internal safety check assembly that opens when the two are connected together. Spring force and pressure close both checks when disconnected to provide a leak free seal. The ME220M will fit any refill adapter on the market.

The ME790 Series is designed to provide a fast and reliable connection for filling motor fuel cylinders through the 1-1/4" male Acme service valve connector.

The Moto-Seal Low Emission Connector (ME220FSN) and Filler Valve (ME790SN) are the **industry's leader** in reducing product emissions without sacrificing flow emitting less than .3 CC during disconnect. The replaceable sealing tip allows the valve to make a bottom face seal when coupled with any mating motor fuel cylinder valve connector.

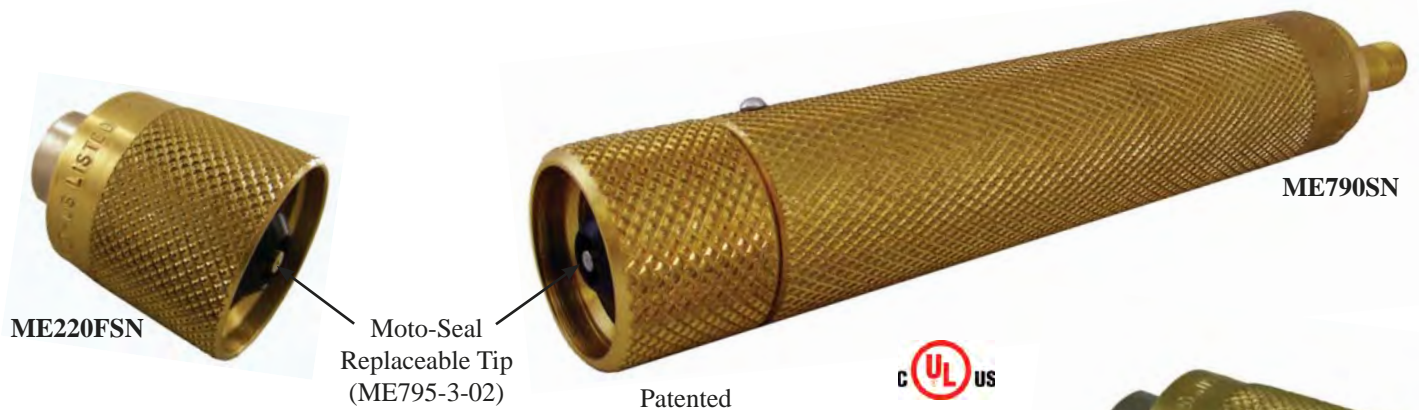

Engine Fuel Valves & Connectors

- Knurled body on the fuel line connector and filler valve allows for an easy hand tight connection even under tank pressure
- Works in conjunction with all mating forklift connectors and filler valves
- ME220F series has a durable riveted valve stem, chrome plated body and wrench flats for easy installation
- ME220M has two seals—an O-ring to minimize product loss during connection and a gasket to seal the two connectors during filling operations
- Moto-Seal connector and filler offers
 - Replaceable tip for maximum service life
 - Positive seal every time with less than **.3 CC** product loss at disconnect
 - 3 layers of security against possible leaks or connection failures when the O-ring and flat gasket are intact on the male connector



Part No.	Moto-Seal Part No.	Inlet	Outlet	Application	Protective Brass Cap
ME220F	ME220FSN	1-1/4" Female Acme	1/4" FNPT	Fuel Line	—
ME220M	—	3/8" FNPT	1-1/4" Male Acme	Service Valve	ME220FP
ME790	ME790SN	1-1/4" Female Acme	1/4" MNPT	Filler Valve	—



Type I (QCC) Quick Filler Coupling

Designed to provide a fast, reliable connection for filling cylinders with Type I (QCC) style valves. The snap on/snap off design is intended to reduce labor and repetitive motion associated with threaded type filler couplings. This easy to operate filler coupling is durable, lightweight and will withstand the harshest working conditions while reducing cylinder valve thread wear. **Note: A quick closing shutoff valve must be used with this coupling.**



ME791CJ
Not Included

Type I (QCC) Quick Filler Coupling Features

- Durable glass filled nylon handle
- Easy to use **snap on/snap off** action for quick fill operation
- All stainless steel internal components
- Large bore stainless steel stem for increased flow
- Right or left hand operation
- Universal filler connection for all Type I (QCC) service valves



Part No.	Inlet	Outlet
ME796	1/4" MNPT	1-5/16" Female Acme Quick Connect

Patented

Type I (QCC) Filler Couplings & Adapters

These full size Type I (QCC) filler couplings make filling DOT propane cylinders with a QCC connection quick and easy. Just a few turns allows the filler to attach and remove the coupling with minimal effort and loss of product. A longer body allows the filler coupling handle to remain outside the fixed collar of a cylinder. Can be used on a manual, electric or hydraulic system. In a manual system a shutoff valve (ME791C, ME791CJ, ME792C or ME792CJ) should be used with the filler coupling.

Warning: It is illegal to fill a 40 pound or less DOT propane cylinder that has a standard POL connection.

Part No.	Inlet	Outlet	Handle Style	Body/Nipple Material	OAL
ME515	1/4" MNPT	1-5/16" Female Acme	Knurled	Brass/Brass	7"
ME516	1/4" MNPT	1-5/16" Female Acme	Heavy Duty Forged	Brass/Brass	6"
ME516S	1/4" MNPT	1-5/16" Female Acme	Heavy Duty Forged	Brass/Stainless Steel	6"



ME516S



ME515

The Type I (QCC) thread replaces the POL connection on 40 pound or less DOT propane cylinders. Marshall Excelsior has developed numerous adapters to allow quick conversion from Type I (QCC) to different fill applications for retailers who fill both 40 pound or less and larger propane cylinders through the same line. Simply hand tighten the adapter to the Type I (QCC) filler coupling (ME515 or ME516 Series).



ME393



ME393HD



ME394

Part No.	Inlet	Outlet	Handle Style	Converts Type I (QCC) Filler Coupling to
ME393	1-5/16" Male Acme/Female POL	Male Soft Nose POL	Knurled	POL Filler Coupling
ME393HD	1-5/16" Male Acme/Female POL	Male Soft Nose POL	Heavy Duty Forged	POL Filler Coupling
ME394	1-5/16" Male Acme/Female POL	1-1/4" Female Acme	Knurled	Motor Fuel Filler Coupling
ME569	1-5/16" Male Acme/Female POL	1-3/4" Female Acme	Knurled	Tank Filler Coupling



ME569

Type I (QCC) / OPD Valve Cap

Designed to protect the 1-5/16" male Acme threads on Type I (QCC) or OPD type cylinder valves. Using a cap will reduce the likelihood of inadvertent damage to the valve's threads, shutoff mechanisms and sealing surfaces during storage or refurbishment.

Part No.		Fits
Brass	Black Vinyl	
ME392P	ME952-07	1-5/16" Female Acme



ME952-07



ME392P



ME392P installed on 20 LB cylinder

Type I (QCC) Connectors

The Type I (QCC) connectors (ME517, ME518 and ME519 Series) are designed with a built-in excess flow feature and a positive shutoff that will not allow gas to flow until the connector is fully engaged. In case of a fire the built-in thermal protection on the QCC connector melts allowing the nipple to disengage from the tank connection and stop the flow of propane. These QCC connectors also provide a positive back check seal at disconnect to eliminate the propane in the hose from being released into the atmosphere.

To connect a Type I (QCC) connector to a cylinder, close the cylinder valve and the control valves to all connected appliances. Hand tighten the QCC onto the cylinder and slowly open the cylinder valve. If the valve is opened too quickly, the excess flow device will be activated closing the flow of propane to the appliance. If the excess flow device is activated, close appliance control valves and wait 60 seconds to allow pressure in the line to equalize. Additional equalization time may be needed depending on the length of the hose. Turn on appliances by following the manufacturer's suggested lighting procedures.

Note: The Type I (QCC) thread replaces the POL connection on 40 pound or less DOT propane cylinders.



ME517



ME518-25H



ME519



ME517EV



Part No.			Inlet	Flow Capacity	Handwheel Color	Thermal Protection
Outlet						
1/4" MNPT	1/4" Hose Barb	3/8" Hose Barb				
ME517	ME517-25H	ME517-38H	1-5/16" Female Acme	50 SCFH Air/100,000 BTUH	Black	Yes
ME518	ME518-25H	ME518-38H	1-5/16" Female Acme	100 SCFH Air/200,000 BTUH	Green	Yes
ME519	ME519-25H	ME519-38H	1-5/16" Female Acme	200 SCFH Air/400,000 BTUH	Red	Yes

Part No.	Inlet	Flow Capacity	Handwheel Color	Thermal Protection	Description
ME517EV	1-5/16" Female Acme	Full Flow	Black	Yes	Evacuation Coupling

Warning: An excess flow valve will not activate if there is a break or leak downstream of the valve that does not equal or exceed the closing flow of the valve or if the excess flow valve installed exceeds the flow capacity of the system. See the Excess Flow Warning page for more information regarding the use of excess flow devices.



Gas Box™

Designed to **eliminate** the need for a 20 LB cylinder or modifications generally needed to plumb an outdoor appliance to a DOT or ASME stationary tank. The Gas Box™ utilizes the standard LP-Gas outdoor appliance regulator and connector. Simply hard plumb a gas line from the first stage regulator into the Gas Box™. Then thread the standard Type I (QCC) or POL connector onto the Gas Box™, turn on the shutoff valve and enjoy continuous LP-Gas flow. Both models provide full capacity operation at 10 psig or higher inlet pressures for all outdoor appliances without modifications.

The Gas Box™ is an easy way to guarantee **increased propane sales**. It eliminates the need for 20 pound cylinders, allowing the customer to purchase any appliance without modifications.

Gas Box™ Features

- Universal Type I (QCC)/female POL outlet connection
- Primary shutoff valve for each outlet connection
- Secondary safety shutoff poppet at each outlet for zero discharge at disconnect
- For use with 10-250 psig inlet pressure
- Universal mounting hardware
- Hinged cover with latching mechanism
- Weather resistant high density polyethylene case

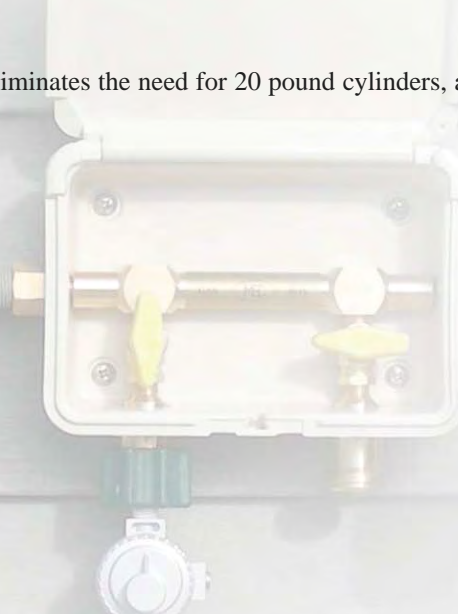

Part No.			Inlet	Outlet	No. of Outlets	Accessories
Color						
Black	Gray	Ivory				
ME951BLK	ME951GRY	ME951IVY	1/2" FNPT	1-5/16" Male Acme/Female POL	Single	MER428-60 = 60" Extension Hose MER428-120 = 120" Extension Hose (Male QCC/Female POL x Female QCC)
ME952BLK	ME952GRY	ME952IVY	1/2" FNPT	1-5/16" Male Acme/Female POL	Dual	

Flow rate / Capacity specifications

Model ME951 – Single outlet *

- 750,000 BTU/HR – 100 psig inlet pressure / Outlet regulated @ 9.5 – 13 in. W.C. (11" nom.)
- 450,000 BTU/HR – 10 psig inlet pressure / Outlet regulated @ 9.5 – 13 in. W.C. (11" nom.)

Model ME952 – Dual outlet *

One outlet closed

- 750,000 BTU/HR – 100 psig inlet pressure / Outlet regulated @ 9.5 – 13 in. W.C. (11" nom.)
- 450,000 BTU/HR – 10 psig inlet pressure / Outlet regulated @ 9.5 – 13 in. W.C. (11" nom.)

Both outlets open (at each outlet)

- 750,000 BTU/HR – 100 psig inlet pressure / Outlet regulated @ 9.5 – 13 in. W.C. (11" nom.)
- 325,000 BTU/HR – 10 psig inlet pressure / Outlet regulated @ 9.5 – 13 in. W.C. (11" nom.)

*These are average capacities and may change slightly due to pressure drop depending on individual installation conditions and length of gas supply runs for the service line. The BTU capacities shown will be further reduced by the flow limiting device in the female type I connection provided with the appliance being attached to the gas box.



Marshall Excelsior

Gas Connections

Type I (QCC) Installation Adapters

Designed to provide a safe permanent outlet when installed into the household LP-Gas system. This permanent outlet eliminates the need for smaller containers when operating outdoor LP-Gas equipment. It is recommended that a shutoff valve be installed upstream from the adapter inlet to facilitate future servicing.

Note: To use the female POL on the ME393 series, simply remove the internal gasket. The gasket must be in place to use the Type I (QCC) connection.

Type I (QCC) Installation Adapter Features

- Can be used with both Type I (QCC) and male POL connections
- ME398 and ME399 include an internal shutoff valve which provides a leak free means for outdoor equipment to be safely connected and disconnected without shutting down the entire system



ME399



ME398P



ME393-1

Part No.	Packaged Part No.	Inlet	Outlet	Shutoff Device
ME393-1	—	1/4" FNPT	1-5/16" Male Acme/Female POL	—
ME393EX	—	1/4" FNPT	1-5/16" Male Acme/Female POL	.9 GPM Excess Flow*
ME393EX1.8	—	1/4" FNPT	1-5/16" Male Acme/Female POL	1.8 GPM Excess Flow*
ME398	ME398P**	Male Soft Nose POL	1-5/16" Male Acme/Female POL	Quick Closing
ME399	—	1/4" MNPT	1-5/16" Male Acme/Female POL	Quick Closing

* An excess flow device does not provide a 100% shutoff, a small amount of propane may leak if disconnected
 ** Packaged option consists of a plastic clamshell

Warning: An excess flow valve will not activate if there is a break or leak downstream of the valve that does not equal or exceed the closing flow of the valve or if the excess flow valve installed exceeds the flow capacity of the system. See the Excess Flow Warning page for more information regarding the use of excess flow devices.

Cylinder Collars

These steel propane cylinder collars are designed to protect the valve installed on a cylinder. An automotive grade powder coat finish provides maximum corrosion resistance.

Warning: It is illegal to fill a tank without a protective collar. Without a protective collar serious damage can occur to the cylinder valve which can lead to catastrophic events such as the tank becoming a dangerous projectile, an explosion and/or fire causing property damage, or personal injury or death.

Part No.	Size	*Multi-Valve
ME312-5MV	3-1/8"	Yes
ME350	3-1/2"	No
ME350MV	3-1/2"	Yes

* Multi-Valve style features cut-out in thread to provide clearance for assembly over container valve



ME350



ME350MV



Quick Acting Toggle Valves

Designed for use primarily on cylinder filling operations and industrial applications where quick and precise on/off operation is necessary. Note: This valve flows in one direction. Installing the valve in the opposite direction of the arrow may cause the valve to not close properly and/or pump pressure may open the valve.

Quick Acting Toggle Valve Features

- Positive shutoff
- Corrosion resistant brass construction
- One hand operation
- Optional factory installed vent valve for safe release of captured product



Part No.		Inlet	Outlet	Factory Installed Vent Valve
Non-Locking	Locking			
ME791C	ME792C	1/2" FNPT	1/4" FNPT	No
ME791CJ	ME792CJ	1/2" FNPT	1/4" FNPT	Yes
ME791D	ME792D	1/2" FNPT	1/2" FNPT	No
ME791DJ	ME792DJ	1/2" FNPT	1/2" FNPT	Yes



Methanol Injector

This gravity fed methanol injector provides a fast and efficient method to inject methanol into stationary ASME containers to help prevent condensation from freezing in the propane system.

Warning: Never attempt to refill injector with methanol while connected to a propane container. In order for the tank and methanol injector vapor equalization to occur, no more than 42 ounces of methanol can be contained within the methanol injector.

Methanol Injector Features

- Spark resistant brass connectors and valve
- Durable steel construction body
- Automotive grade powder coat finish for maximum corrosion resistance
- For use with all multi-valve applications or where vapor recovery systems are in place

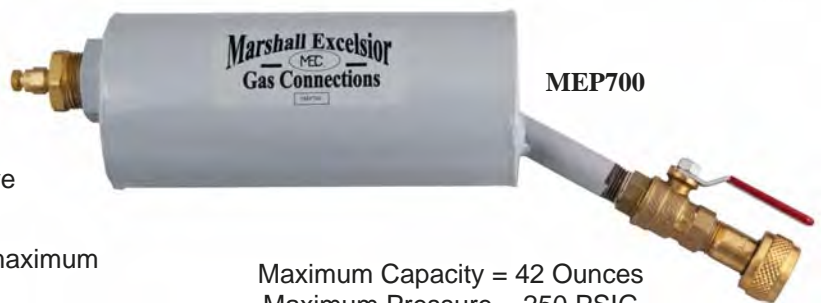

Maximum Capacity = 42 Ounces
Maximum Pressure = 250 PSIG

Part No.	Vapor Connection	Description
MEP700	1-1/4" Female Acme	Assembly
MEP700-01	—	Body Only

POL Filler Couplings & Adapters

These POL filler couplings make filling DOT propane cylinders with a POL connection quick and easy. A few turns allow the soft nose POL to seal and unseal from the mating POL connection with minimal effort and loss of product. The long body models allow the filler coupling handle to remain outside the fixed collar of the cylinder. Can be used on manual, electric or hydraulic system. In a manual system a shutoff valve (ME791C, ME791CJ, ME792C or ME792CJ) should be used with the filler coupling.



ME390



ME388



ME390S

Part No.	Inlet	Outlet	Handle Style	Body/Nipple Material	OAL
ME388	1/4" MNPT	Male Soft Nose POL	Knurled - 2" Dia.	Bass/Brass	2-11/16"
ME390	1/4" MNPT	Male Soft Nose POL	Heavy Duty Forged	Brass/Brass	6"
ME390S	1/4" MNPT	Male Soft Nose POL	Heavy Duty Forged	Brass/Stainless Steel	6"

These adapters allow for quick conversion from a POL connection to various filling applications for retailers who fill multiple cylinder types through the same Type I (QCC) connection. Simply hand tighten the adapter to the POL filler connection (ME388 or ME390 Series).

The ME393-2 allows for quick conversion from M. QCC (ME516) or F. POL (ME390) Fill Adapter to a Male Type II / Quick Fill Connector.



ME392



ME394



ME393-2



ME568

Part No.	Inlet	Outlet	Handle Style	Converts POL Filler Coupling to
ME392	Female POL	1-5/16" Female Acme	Knurled	Type I (QCC) Filler Coupling
ME393-2	Female POL	M. Quick Disconnect	Knurled	Male Type II / Quick Fill Connector
ME394	1-5/16" Male Acme/Female POL	1-1/4" Female Acme	Knurled	Motor Fuel Filler Coupling
ME568	Female POL	1-3/4" Female Acme	Knurled	Tank Filler Coupling

* Replacement M. QCC/F. POL gasket - Part No. MEW3

Cylinder Valve Wrenches

Designed to remove or install Type I (QCC)/OPD cylinder valves or POL service valves without damage to the valve base.



MEP121

Part No.	Thread	Style
MEP121	Male POL	POL
MEP122	1-5/16" Female Acme	Type I (QCC)/ OPD



MEP122



Male POL x 1/4" MNPT

Part No.			Connection	Male POL Description
Male Hard Nose POL	Male Hard Nose POL 90° Angle	Male Soft Nose POL		
ME318 ME318P*	ME345	ME1629	1/4" MNPT	7/8" Nut
ME322	—	—	1/4" MNPT	7/8" Nut, 3-1/2" OAL
—	—	ME1654	1/4" MNPT	Plastic Handwheel
—	—	ME1654AH	1/4" MNPT	Hex Handwheel
—	—	ME1654AR	1/4" MNPT	Round Handwheel
ME319	ME348	—	1/4" MNPT	1-1/8" Nut
ME1690 ME1690P*	—	ME1641	1/4" MNPT	.9 GPM Excess Flow, 7/8" Nut
—	—	ME1653	1/4" MNPT	.9 GPM Excess Flow, Plastic Handwheel
—	—	ME1653AH	1/4" MNPT	.9 GPM Excess Flow, Hex Handwheel
—	—	ME1653AR	1/4" MNPT	.9 GPM Excess Flow, Round Handwheel
ME1692	—	—	1/4" MNPT	.9 GPM Excess Flow, 1-1/8" Nut
ME1690-EX18	—	ME1641EX18	1/4" MNPT	1.8 GPM Excess Flow, 7/8" Nut
—	—	ME1638	1/4" MNPT	#60 Orifice Hole, 7/8" Nut

* Packaged option consists of a plastic clamshell

Male Hard Nose POL



Male Soft Nose POL



Plastic Handwheel

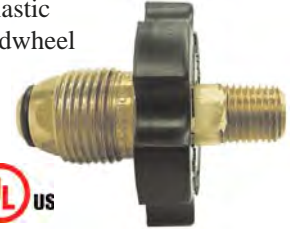

ME345



Male POL x Hose Barbs

Part No.		Hose I.D.	Male POL Description
Male Hard Nose POL	Male Soft Nose POL		
ME5930	ME1656-78N	1/4"	7/8" Nut
ME5931-78N	ME5931-78SN	3/8"	7/8" Nut
ME5930-118N	ME1656-118N	1/4"	1-1/8" Nut
ME5931	ME5931-SN	3/8"	1-1/8" Nut
—	ME1656	1/4"	Plastic Handwheel
—	ME1656AH	1/4"	Hex Handwheel
—	ME1656AR	1/4"	Round Handwheel
ME1683	ME1655-78N	1/4"	.9 GPM Excess Flow, 7/8" Nut
ME5931EX-78N	ME5931SNEX-78N	3/8"	.9 GPM Excess Flow, 7/8" Nut
ME1684	—	1/4"	.9 GPM Excess Flow, 1-1/8" Nut
—	ME1655	1/4"	.9 GPM Excess Flow, Plastic Handwheel
—	ME1655AH	1/4"	.9 GPM Excess Flow, Hex Handwheel
—	ME1655AR	1/4"	.9 GPM Excess Flow, Round Handwheel
—	ME1655EX18-78N	1/4"	1.8 GPM Excess Flow, 7/8" Nut
—	ME1657	1/4"	#60 Orifice Hole, 7/8" Nut

Hex Handwheel



Round Handwheel

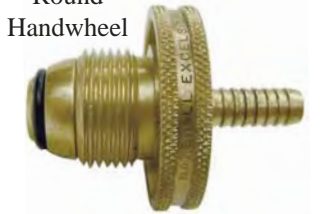

Warning: An excess flow valve will not activate if there is a break or leak downstream of the valve that does not equal or exceed the closing flow of the valve or if the excess flow valve installed exceeds the flow capacity of the system. See the Excess Flow Warning page for more information regarding the use of excess flow devices.

Single Piece POL Adapters

POL x MNPT			
Part No.	POL Connection	Excess Flow	MNPT
ME284	Female	—	1/4"
ME285	Female	—	3/8"
ME286	Female	—	1/2"
ME287	Female	—	3/4"
ME352	Male Hard Nose	—	3/8"
ME354	Male Hard Nose	—	1/2"
ME354EX9	Male Hard Nose	.9 GPM	1/2"
ME354EX18	Male Hard Nose	1.8 GPM	1/2"



POL x Male Flare			
Part No.	POL Connection	Excess Flow	Male Flare
ME353	Male Hard Nose	—	3/8"
ME353-SN	Male Soft Nose	—	3/8"
ME353EX9	Male Hard Nose	.9 GPM	3/8"
ME353EX18	Male Hard Nose	1.8 GPM	3/8"
ME355	Male Hard Nose	—	1/2"
ME355-SN	Male Soft Nose	—	1/2"
ME355EX9	Male Hard Nose	.9 GPM	1/2"
ME355EX18	Male Hard Nose	1.8 GPM	1/2"
ME356	Male Hard Nose	—	5/8"
ME356-SN	Male Soft Nose	—	5/8"
ME356EX9	Male Hard Nose	.9 GPM	5/8"
ME356EX18	Male Hard Nose	1.8 GPM	5/8"

POL x FNPT		
Part No.	POL Connection	FNPT
ME300	Female	1/8"
ME301	Female	1/4"
ME302	Female	3/8"
ME303	Female	1/2"
ME304	Female	3/4"
ME351	Male Hard Nose	1/4"
ME357	Male Hard Nose	1/2"

POL x POL		
Part No.	POL Connection	POL Connection
ME305	Female	Female



Warning: An excess flow valve will not activate if there is a break or leak downstream of the valve that does not equal or exceed the closing flow of the valve or if the excess flow valve installed exceeds the flow capacity of the system. See the Excess Flow Warning page for more information regarding the use of excess flow devices.

POL Cap & Plugs

Part No.			Style
Brass		Plastic	
Body Only	Body With Chain	Body Only	
ME1691	ME1691-1	ME970P	Male Hard Nose POL Plug
ME1699	—	—	Female POL Cap



Safe-T-Locks

Designed to prevent tampering, product theft and/or accidental discharge of product. This product is perfect for any size tank valve with a POL connection or 1-3/4" Acme connection or gas plumbing, such as a riser.

To install, securely screw the plug or cap to the valving or plumbing using the appropriate wrench. Snap locking mechanism into place over plug or cap. Locking mechanism will cover the installation hex or knurl and swivel freely until key is inserted and the lock is removed.

Safe-T-Lock Features

- All brass body construction for maximum durability
- Locking mechanism and key features durable chrome plating
- Locking mechanism swivels 360° when installed to prevent tampering or removal
- Locking mechanism cannot be removed without key
- Universal key for all sizes and styles

Part No.	Thread	Packaging	Additional Keys
ME530	Male Soft Nose POL	12 Plugs & Locks, 1 Key	ME530-03
ME531-50	1/2" FNPT	6 Caps & Locks, 1 Key	ME530-03
ME531-75	3/4" FNPT	6 Caps & Locks, 1 Key	ME530-03
ME532-38	3/8" Male Flare	12 Plugs & Locks, 1 Key	ME530-03
ME532-50	1/2" Male Flare	12 Plugs & Locks, 1 Key	ME530-03
ME533	1-3/4" Female Acme	2 Caps & Locks, 1 Key	ME530-03
ME530PL	Male Soft Nose POL	12 Caps & Locks, 1 Key	ME530-03



POL Thread Clean Out Tool

Designed for use with any female POL thread or valve inlet opening. Allows operator to safely remove debris and other foreign material from female .880-14 NGO left hand threads (female POL) without damaging threads. Simply thread clean out tool into female POL threads using handwheel until the tool reaches the final thread. Reverse and remove tool carefully. Reverse tool and use attached 7/8" diameter bottle brush to perform final clean out operation. Blow out any remaining debris by using a compressed air line.

POL Thread Clean Out Tool

- Constructed from hardened tool steel and plated for maximum product life
- Four clearance flutes to allow debris to be channeled away from threads
- Convenient 7/8" diameter wire brush for final clean out



Warning: The POL thread clean out tool is strictly intended for use as a cleaning device and in no way should be used as a gauge to determine the usability of the thread. (Always refer to NFPA 58 and follow the appropriate guidelines prior to installing LP-Gas lines)

Tee Check Manifolds

These manifolds are designed to connect two cylinders. The check keeps the two tanks equalized and allows each tank to be changed without disrupting the flow of propane to appliances or dispensing large amounts of LP-Gas into the atmosphere from the other tank. When changing out a tank, simply close the tank valve and disconnect. The check will automatically move to the closed tank valve side to seal off the inlet of that tank allowing minimal LP-Gas discharge into the atmosphere. Primary uses are for mobile homes, single appliances, recreational vehicles or summer cottages.

The manual changeover works the same as the check except it requires the consumer to manually close the manifold valve on the side of the tank being changed over.

Part No.	Packaged Part No.	Inlet	Inlet	Outlet	Nut Size
ME1701A	—	Female POL	Female POL	Male Hard Nose POL	7/8"
ME1702A	—	Female POL	Female POL	Male Hard Nose POL	1-1/8"
ME1705A	—	Female POL	Female POL	1/4" MNPT	—
ME1700A	ME1700A-P**	1/4" Female Inverted Flare	1/4" Female Inverted Flare	1/4" MNPT	—
MEP456A*	—	1/4" Female Inverted Flare	1/4" Female Inverted Flare	1/4" MNPT	—

* Manual Change Over ** Packaged option consists of a plastic clam shell



Multiple Cylinder Tee Block Manifolds

These manifolds are designed to connect multiple cylinders to automatic changeover regulators. These manifolds have no check and are primarily for systems requiring more than one cylinder to be in operation at a time. The appropriate pigtail must be used to connect the manifold inlet to the service cylinder valve.

Part No.	Inlet	Inlet	Outlet	Nut Size
ME1701	Female POL	Female POL	1/4" FNPT	—
ME1701B	Female POL	Female POL	Male Hard Nose POL	7/8"
ME1702B	Female POL	Female POL	Male Hard Nose POL	1-1/8"
ME1701B-SN	Female POL	Female POL	Male Soft Nose POL	7/8"
ME1701X	Female POL	Female POL	Male .9 GPM Excess Flow Hard Nose POL	7/8"
ME1701B-X-SN	Female POL	Female POL	Male .9 GPM Excess Flow Soft Nose POL	7/8"
ME1704B	Female POL	Female POL	Female POL	1-1/8"
ME1700B	1/4" Female Inverted Flare	1/4" Female Inverted Flare	1/4" MNPT	—
ME-T9-444	1/4" FNPT	1/4" FNPT	1/4" MNPT	—



Warning: An excess flow valve will not activate if there is a break or leak downstream of the valve that does not equal or exceed the closing flow of the valve or if the excess flow valve installed exceeds the flow capacity of the system. See the Excess Flow Warning page for more information regarding the use of excess flow devices.



Camping Tees



ME412



ME413



ME414



ME415



ME416



ME418



ME420P



ME424



ME421



ME422



ME425

Part No.	Packaged Part No.	Inlet	Auxiliary Inlet	Outlet	Outlet
ME412	—	1-5/16" Female Acme	—	1"-20 Male	1"-20 Male
ME413	ME413P*	#60 Male Soft Nose POL with Round Brass Handwheel	—	1"-20 Male	1"-20 Male
ME414	ME414P*	1"-20 Female	—	1"-20 Male	1"-20 Male
ME415	ME415P*	.9 GPM Excess Flow Male Hard Nose POL	—	Female POL	1"-20 Male
ME416	—	.9 GPM Excess Flow Male Hard Nose POL with Plastic Handwheel	—	Female POL	Female POL
ME418	—	1-5/16" Female Acme	—	1-5/16" Male Acme/Female POL with Quick Closing Poppet	1"-20 Male
ME420	ME420P*	.9 GPM Excess Flow Male Hard Nose POL	1/4" Female Inverted Flare with Check	Female POL	1"-20 Male
ME421	—	.9 GPM Excess Flow Male Hard Nose POL	—	1-5/16" Male Acme/Female POL with Quick Closing Poppet	1"-20 Male
ME422	—	1-5/16" Female Acme	1/4" Female Inverted Flare	1-5/16" Male Acme/Female POL with Quick Closing Poppet	1"-20 Male
ME424	—	.9 GPM Excess Flow Male Hard Nose POL	1/4" Female Inverted Flare with Check	1-5/16" Male Acme/Female POL with Quick Closing Poppet	1"-20 Male
ME425	—	.9 GPM Excess Flow Male Soft Nose POL	1/4" Female Inverted Flare with Check	1-5/16" Male Acme/Female POL with Quick Closing Poppet	1"-20 Male

* Packaged option consists of a plastic clamshell

Warning: An excess flow valve will not activate if there is a break or leak downstream of the valve that does not equal or exceed the closing flow of the valve or if the excess flow valve installed exceeds the flow capacity of the system. See the Excess Flow Warning page for more information regarding the use of excess flow devices.

Camping Elbows & Assemblies



ME423



ME481P



ME474



ME475AR



ME477



ME475B



ME475



ME497

Part No.	Packaged Part No.	Inlet	Outlet	Outlet
ME423	ME423P*	.9 GPM Excess Flow Male Hard Nose POL	1-5/16" Male Acme/Female POL with Quick Closing Poppet	1"-20 Male
ME474	—	1-5/6" Female Acme	1"-20 Male	—
ME475	ME475P*	#60 Male Soft Nose POL with Plastic Handwheel	1"-20 Male	—
ME475AR	—	#60 Male Soft Nose POL with Round Brass Handwheel	1"-20 Male	—
ME475B	—	#60 Male Soft Nose POL	1"-20 Male	—
ME477	—	.9 GPM Excess Flow Male Hard Nose POL with Plastic Handwheel	1"-20 Male	—
ME481	ME481P*	1"-20 Female	1-5/16" Male Acme/Female POL with Quick Closing Poppet	—
ME497	—	Male Soft Nose POL with Plastic Handwheel	1"-20 Male	—
ME497AR	—	Male Soft Nose POL with Round Brass Handwheel	1"-20 Male	—

* Packaged option consists of a plastic clamshell



ME497AR

Warning: An excess flow valve will not activate if there is a break or leak downstream of the valve that does not equal or exceed the closing flow of the valve or if the excess flow valve installed exceeds the flow capacity of the system. See the Excess Flow Warning page for more information regarding the use of excess flow devices.



Camping Fittings



ME417



ME483



ME484



ME485



ME487



ME488



ME492



ME493



ME494



ME496

Part No.	Packaged Part No.	Inlet	Outlet
ME417	—	1/4" MNPT	1"-20 Male with Check & O-ring
ME483	—	1"-20 Female Cap with Strap	—
ME484	—	1"-20 Female	1/4" Hose Barb
ME485	—	1"-20 Female	1/4" FNPT
ME487	ME487P*	1"-20 Female	Female POL
ME488	ME488P*	1"-20 Female	1/4" MNPT
ME491	—	3/8" Male Flare	1"-20 Male with Check & O-ring
ME492	ME492P*	1/4" FNPT	1"-20 Male - No Check
ME493	—	9/16"-18 Male Left Hand	1"-20 Male with Check & O-ring
ME494	—	9/16"-18 Male Left Hand	1"-20 Male - No Check
ME496	—	1/4" Hose Barb	1"-20 Male Swivel with Valve Stem & O-ring

* Packaged option consists of a plastic clamshell



ME487P

Flow-Longer & Stay-Longer Kits

The **Flow-Longer** Propane Kits are designed to connect small, portable appliances, normally fueled by disposable LP-Gas cylinders, to the existing LP-Gas fuel supply of a recreational vehicle, cottage, backyard patio, etc. without interrupting the supply of regulated fuel to the system. **Flow-Longer** eliminates the need to purchase an extra LP-Gas cylinder or several small, disposable type cylinders.

MER470 Flow-Longer Propane Kit Includes

- Brass tee connection (ME415) .9 GPM excess flow male hard nose POL x female POL x 1"-20 male
- 12 foot hose (MER421-144) 1"-20 male x 1"-20 female

MER471 Flow-Longer Plus Propane Kit Includes

- Brass elbow connection (ME423) .9 GPM excess flow male hard nose POL x 1-5/16" male Acme/female POL with quick closing poppet x 1"-20 female
- 12 foot hose (MER421-144) 1"-20 male x 1"-20 female



MER470



MER471

The **Stay-Longer** Propane Kits are designed to give you new flexibility on how you use your LP-Gas. You can stay longer by hooking up auxiliary LP-Gas cylinders, or you can tap into the RV's LP-Gas system to fuel portable high-pressure appliances.

MER472 Stay-Longer Propane Kit Includes

- Brass tee connection (ME420) .9 GPM excess flow male hard nose POL x female POL x 1"-20 male x 1/4" female inverted flare
- 5 foot hose (MER401-60) .9 GPM excess flow male POL x 1/4" male inverted flare

MER473 Stay-Longer Plus Propane Kit Includes

- Brass tee connection (ME420) .9 GPM excess flow male hard nose POL x female POL x 1"-20 male x 1/4" female inverted flare
- 5 foot hose (MER401-60) .9 GPM excess flow male hard nose POL x 1/4" male inverted flare
- 12 foot hose (MER421-144) 1"-20 male x 1"-20 female



MER472



MER473

All kits include installation instructions and a convenient reusable box for storage.

Note: The tee fitting must be installed between the vapor withdrawal valve on your LP-Gas container and the pressure regulator. This properly places the tee fitting in the high pressure portion of the LP-Gas system. Gas connections to the tee fitting are not designed for movement or rotation after installation. Flexing, twisting, or vibration should be avoided.

Warning: An excess flow valve will not activate if there is a break or leak downstream of the valve that does not equal or exceed the closing flow of the valve or if the excess flow valve installed exceeds the flow capacity of the system. See the Excess Flow Warning page for more information regarding the use of excess flow devices.



Last Chance Adapters

Designed to provide a quick way to change from a 20 pound cylinder to a 1 pound disposable cylinder. Can be used to connect a small 1 pound disposable cylinder to a gas grill or other appliance.

Note: To use the male POL on the ME393 series, simply remove the internal gasket. The gasket must be in place to use the Type I (QCC) connection.



ME480EX



ME480



ME481P

Part No.	Packaged Part No.	Inlet	Outlet	Description
ME480	—	1"-20 Female	1-5/16" Male Acme/Female POL	Full Flow
ME480EX	—	1"-20 Female	1-5/16" Male Acme/Female POL	.9 GPM Excess Flow
ME480EX1.8	—	1"-20 Female	1-5/16" Male Acme/Female POL	1.8 GPM Excess Flow
ME481	ME481P**	1"-20 Female	1-5/16" Male Acme/Female POL	Shutoff Poppet

* An excess flow device does not provide a 100% shutoff, a small amount of propane may leak if disconnected
 ** Packaged option consists of a plastic clamshell

Warning: An excess flow valve will not activate if there is a break or leak downstream of the valve that does not equal or exceed the closing flow of the valve or if the excess flow valve installed exceeds the flow capacity of the system. See the Excess Flow Warning page for more information regarding the use of excess flow devices.

MEC Space Saver Dielectric Unions

The ME690 series dielectric unions are intended to isolate metallic piping from sources of electrical current and to help prevent galvanic corrosion. The ME690 dielectric union would typically be installed at the ASME tank directly downstream of the first stage regulator but prior to underground piping and/or at the inlet of the second stage regulator above ground at the dwelling there by protecting the underground metallic piping from corrosion and electrical current.

Dielectric Union Features

- Heavy duty brass construction
- Convenient male NPT x male SAE flare connection to minimize potential piping leak points and extra fittings
- Compact size for tight spaces
- Wide wrench flats for easy installation
- Will not conduct an electrical charge from one side of the union to the other



ME690-4-8

Part No.	Description	OAL
ME690-4-6	Dielectric Union 1/2" MNPT x 3/8" Male Flare	3-3/8"
ME690-6-6	Dielectric Union 3/4" MNPT x 3/8" Male Flare	3-1/2"
ME690-4-8	Dielectric Union 1/2" MNPT x 1/2" Male Flare	3-1/2"
ME690-6-8	Dielectric Union 3/4" MNPT x 1/2" Male Flare	3-5/8"
ME690-4-10	Dielectric Union 1/2" MNPT x 5/8" Male Flare	3-5/8"
ME690-6-10	Dielectric Union 3/4" MNPT x 5/8" Male Flare	3-3/4"

Flare Fittings



Short Forged Nuts	
Part No.	O.D. Tube Size
ME-NS4-4	1/4"
ME-NS4-6	3/8"
ME-NS4-8	1/2"
ME-NS4-10	5/8"
ME-NS4-12	3/4"



Reducing Forged Nuts	
Part No.	O.D. Tube Size
ME-NS4-6-4	3/8" x 1/4"
ME-NS4-8-4	1/2" x 1/4"
ME-NS4-8-6	1/2" X 3/8"
ME-NS4-10-8	5/8" X 1/2"



Forged Swivel Nuts	
Part No.	O.D. Tube Size
ME-US4-6	3/8"
ME-US4-8	1/2"
ME-US4-10	5/8"

Reducing Forged Swivel Nuts	
Part No.	O.D. Tube Size
ME-US4-8-6	1/2" x 3/8"
ME-US4-10-8	5/8" x 1/2"



Full Unions	
Part No.	O.D. Tube Size
MEF42-4-4	1/4"
MEF42-6-6	3/8"
MEF42-8-8	1/2"
MEF42-10-10	5/8"



Reducing Unions	
Part No.	O.D. Tube Size
MEF42-8-6	1/2" x 3/8"
MEF42-10-6	5/8" x 3/8"
MEF42-10-8	5/8" x 1/2"



Female Connectors		
Part No.	O.D. Tube Size	FNPT
MEF46-4-4	1/4"	1/4"
MEF46-6-4	3/8"	1/4"
MEF46-6-6	3/8"	3/8"
MEF46-6-8	3/8"	1/2"
MEF46-6-12	3/8"	3/4"
MEF46-8-6	1/2"	3/8"
MEF46-8-8	1/2"	1/2"
MEF46-8-12	1/2"	3/4"
MEF46-10-6	5/8"	3/8"
MEF46-10-8	5/8"	1/2"
MEF46-10-12	5/8"	3/4"



Male Connectors		
Part No.	O.D. Tube Size	MNPT
MEF48-4-2	1/4"	1/8"
MEF48-4-4	1/4"	1/4"
MEF48-6-2	3/8"	1/8"
MEF48-6-4	3/8"	1/4"
MEF48-6-6	3/8"	3/8"
MEF48-6-8	3/8"	1/2"
MEF48-6-12	3/8"	3/4"
MEF48-8-4	1/2"	1/4"
MEF48-8-6	1/2"	3/8"
MEF48-8-8	1/2"	1/2"
MEF48-8-12	1/2"	3/4"
MEF48-10-6	5/8"	3/8"
MEF48-10-8	5/8"	1/2"
MEF48-10-12	5/8"	3/4"
MEF48-12-8	3/4"	1/2"
MEF48-12-12	3/4"	3/4"



Forged Female Elbows		
Part No.	O.D. Tube Size	FNPT
MEF54-6-6	3/8"	3/8"
MEF54-6-8	3/8"	1/2"
MEF54-6-12	3/8"	3/4"
MEF54-8-6	1/2"	3/8"
MEF54-8-8	1/2"	1/2"
MEF54-8-12	1/2"	3/4"
MEF54-10-8	5/8"	1/2"
MEF54-10-12	5/8"	3/4"



Flare Fittings & Pipe Thread Adapters



Forged Male Elbows		
Part No.	O.D. Tube Size	MNPT
MEF49-4-6	1/4"	3/8"
MEF49-6-4	3/8"	1/4"
MEF49-6-6	3/8"	3/8"
MEF49-6-8	3/8"	1/2"
MEF49-6-12	3/8"	3/4"
MEF49-8-4	1/2"	1/4"
MEF49-8-6	1/2"	3/8"
MEF49-8-8	1/2"	1/2"
MEF49-8-12	1/2"	3/4"
MEF49-10-8	5/8"	1/2"
MEF49-10-12	5/8"	3/4"



2 Way Forged Elbows	
Part No.	O.D. Tube Size
MEF55-6	3/8"
MEF55-8	1/2"
MEF55-10	5/8"
MEF55-12	3/4"



Male Tee	
Part No.	O.D. Tube Size
MEF44-6-6-6	3/8"
MEF44-8-8-8	1/2"
MEF44-10-10-10	5/8"



RV Bulkhead		
Part No.	Packaged Part No.	Description
MESTF33	MESTF33P	3/8" M. Flare x 3/8" M. Flare

* Packaged option consists of a plastic clamshell



Flare Plugs	
Part No.	O.D. Tube Size
MEP2-4	1/4"
MEP2-6	3/8"
MEP2-8	1/2"
MEP2-12	3/4"



Female Tee	
Part No.	FNPT
ME415-01	1/4"



Flare Caps	
Part No.	O.D. Tube Size
ME1695-4	1/4"
ME1695-6	3/8"
ME1695-8	1/2"
ME1695-12	3/4"



Pipe Threads Unions		
Part No.	MNPT	MNPT
MEF216-2	1/8"	1/8"
MEF216-4	1/4"	1/4"
MEF216-6	3/8"	3/8"
MEF216-6-8	3/8"	1/2"
MEF216-8	1/2"	1/2"
MEF216-8-4	1/2"	1/4"
MEF216-12	3/4"	3/4"



Inverted Flare Adapter		
Part No.	Description	Accessory
ME2132	1/4" F. Inv. Flare x 1/4" MNPT	ME2131 1/4" Inverted Flare Plug



Tube Nut	
Part No.	O.D. Tube Size
MEF41-6	3/8"

CGA 555 Fittings

CGA 555 adapters are standard cylinder valve outlet connections for liquid butane or propane withdrawal. They are designed to withstand pressures up to 3,000 psig.

Part No.	Inlet	Outlet
ME306	Female CGA 555	1/4" MNPT
ME307	Female CGA 555	9/16"-18 Male Left Hand
ME308	Female CGA 555	Female POL



Part No.	Cap with Chain
ME309-1	CGA 555



High Pressure Gas Connections

Part No.			Hose I.D.	Threads
Hose Barb Assembly	Hose Barb Only	Nut Only		
ME23C	ME23C-1	ME23C-2	1/4"	9/16"-18 Female Left Hand
ME23E	ME23E-1	ME23C-2	3/8"	9/16"-18 Female Left Hand



Part No.		Connection	POL Description
Male Hard Nose POL	Male Soft Nose POL		
ME1650	ME1650SN	9/16"-18 Male Left Hand	7/8" Nut
ME1651	—	9/16"-18 Male Left Hand	1-1/8" Nut
ME1689	ME1645-78N	9/16"-18 Male Left Hand	.9 GPM Excess Flow, 7/8" Nut
—	ME1645	9/16"-18 Male Left Hand	.9 GPM Excess Flow, Plastic Handwheel
ME1687	—	9/16"-18 Male Left Hand	.9 GPM Excess Flow, 1-1/8" Nut
ME1689-EX18	—	9/16"-18 Male Left Hand	1.8 GPM Excess Flow, 7/8" Nut

Soft Nose POL



Hard Nose POL



Outlet Bushings		
Part No.	Male Left Hand Thread	Thread
ME24C	9/16"-18	1/4" MNPT
ME24E	9/16"-18	3/8" MNPT
ME24F	9/16"-18	1/2" MNPT
ME26C	9/16"-18	9/16"-18 Male Left Hand



ME24C

Warning: An excess flow valve will not activate if there is a break or leak downstream of the valve that does not equal or exceed the closing flow of the valve or if the excess flow valve installed exceeds the flow capacity of the system. See the Excess Flow Warning page for more information regarding the use of excess flow devices.



Copper Pigtails and Hogtails

These pigtail and hogtail assemblies come with two brass connectors brazed onto a heavy wall annealed copper tube with a 250 psig pressure rating. The 1/4" and 3/8" tube have a pull test rating of 500 and 750 pounds respectively.  LISTED and tested in accordance with UL 569.

Different applications require specific pigtail and hogtail assemblies. Special attention is required when ordering to ensure the proper assembly is purchased for the intended application. Marshall Excelsior recommends every new installation or replacement regulator have a new pigtail installed.

***ME1600D Series Dielectric pigtails/ hogtails** are intended to isolate metallic piping from sources of electrical current and to help prevent galvanic corrosion when used on underground containers. The ME1600D dielectric pigtail/ hogtail would typically be installed at the ASME tank directly upstream of the first stage regulator prior to underground piping, isolating the underground metallic piping from electric current.

Description	Approx. Length	Part No.			
		1/4" Tube OD		3/8" Tube OD	
		Long Nipple	Short Nipple	Long Nipple	Short Nipple
Male Hard Nose POL x Male Hard Nose POL, 7/8" Nut	6	—	ME1664-06	ME1680L-06	ME1680-06
	12	ME1662-12*	ME1664-12*	ME1680L-12*	ME1680-12*
	20	ME1662-20*	ME1664-20*	ME1680L-20*	ME1680-20*
	30	ME1662-30	ME1664-30	ME1680L-30	ME1680-30
	36	ME1662-36	ME1664-36	ME1680L-36	ME1680-36
	48	ME1662-48	ME1664-48	ME1680L-48	ME1680-48
Male Hard Nose POL x Male Hard Nose POL, 1-1/8" Nut	20	ME1660-20	—	—	ME1680HD-20
	30	ME1660-30	—	—	—
	36	ME1660-36	—	—	—
	48	ME1660-48	—	—	—
1/4" Male Inverted Flare x Male Hard Nose POL, 7/8" Nut	15	—	ME1665-15	—	—
	20	ME1663-20	ME1665-20	—	—
	30	ME1663-30	ME1665-30	—	—
	36	ME1663-36	ME1665-36	—	—
	48	ME1663-48	ME1665-48	—	—
1/4" Male Inverted Flare x Male Hard Nose POL, 1-1/8" Nut	20	ME1661-20	—	—	—
	30	ME1661-30	—	—	—
	36	ME1661-36	—	—	—
	40	ME1661-40	—	—	—
1/4" MNPT x Male Hard Nose POL, 7/8" Nut	6	ME1679-06	ME1669-06	—	ME1689-06
	12	ME1679-12*	ME1669-12*	ME1689L-12	ME1689-12
	18	ME1679-18	ME1669-18*	—	—
	20	ME1679-20*	ME1669-20	ME1689L-20	ME1689-20
	30	ME1679-30	ME1669-30	ME1689L-30	ME1689-30
	36	ME1679-36	ME1669-36	—	ME1689-36
	48	ME1679-48	ME1669-48	ME1689L-48	ME1689-48
1/4" MNPT x Male Hard Nose POL, 1-1/8" Nut	20	ME1679HD-20	—	—	—
	48	ME1679HD-48	—	—	—
1/2" MNPT x Male Hard Nose POL, 7/8" Nut	12	—	—	ME1684L-12	ME1684-12
	20	—	—	ME1684L-20	ME1684-20

* Note: Dielectric option available. Add "D" after the prefix part number i.e. ME1662D-12

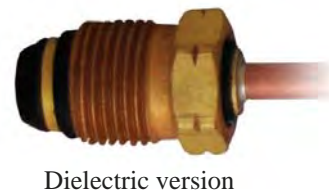

Bent Copper Pigtails and Hogtails

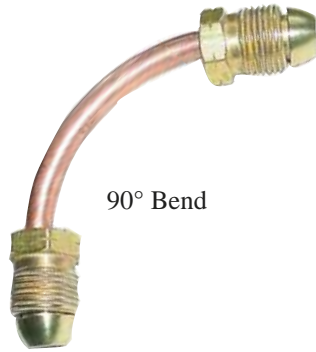

90° Bend



270° Bend Right Hand

Part No.	Approximate Length	1/4" Tube OD Short Nipple	3/8" Tube OD Short Nipple		
		90°	90°	270° Right	360°
Male Hard Nose POL x Male Hard Nose POL, 7/8" Nut	12	—	ME1680-12B90	ME1680-12B270R	ME1680-12B360
1/4" MNPT x Male Hard Nose POL, 7/8" Nut	5	ME1669-5B90	ME1689-5B90	—	—
	6	ME1669-6B90	ME1689-6B90	—	—

Thermoplastic Hoses

Flexible thermoplastic UL and CGA approved hose. These hoses are rated up to 350 psig working pressure with a 400 pound pull test rating. Each hose comes with two ends and fully crimped brass ferrules.

Warning: An excess flow valve will not activate if there is a break or leak downstream of the valve that does not equal or exceed the closing flow of the valve or if the excess flow valve installed exceeds the flow capacity of the system. See the Excess Flow Warning page (PG. 18) for more information regarding the use of excess flow devices.



MNPT



3/8" Female Swivel

Part No. 3/8" Hose ID	Approximate Lengths "X"*	Connection	Connection
MER610-"X"	24, 30, 36, 48, 60, 120, 144, 240	3/8" MNPT	3/8" Female Flare Swivel
MER611-"X"	24, 30, 36, 40, 48, 60	1/2" Female Flare Swivel	3/8" MNPT
MER613-"X"	18, 24, 30, 36, 48, 60, 72, 120, 144, 180, 240, 300	3/8" Female Flare Swivel	3/8" Female Flare Swivel

* Replace "X" with the desired hose length i.e. MER610-48



Thermoplastic Hoses

Part No. 1/4" Hose ID	Approximate Length "X"*	Connection	Connection
MER409-"X"	15, 20, 24, 36, 60	Male Hard Nose POL, 7/8" Nut	Male Hard Nose POL, 7/8" Nut
MER428-"X"	60, 120	Female QCC, Type I Connection	Male QCC, Type I Connection with Female POL
MER412-"X"	20	.9 GPM Excess Flow Male Hard Nose POL, 7/8" Nut	.9 GPM Excess Flow Male Hard Nose POL, 7/8" Nut
MER425-"X"	12, 15, 18, 20, 24, 30, 36, 48, 60	Female QCC, Type I Connection	1/4" Male Inverted Flare
MER427-"X"	20	Female QCC, Type I Connection	3/8" Female Flare Swivel
MER403-"X"	12, 15, 18, 20, 24, 30, 36, 48, 60, 72, 120, 240	Male Hard Nose POL, 7/8" Nut	1/4" Male Inverted Flare
MER401-"X"	12, 15, 18, 20, 24, 30, 36, 48, 60	.9 GPM Excess Flow Male POL, 7/8" Nut	1/4" Male Inverted Flare
MER423-"X"	15, 20, 24, 30, 36	.9 GPM Excess Flow Male Soft Nose POL, Plastic Handwheel	1/4" Male Inverted Flare
MER404-"X"	15, 18, 20, 24, 36	#60 Orifice Hole Male Soft Nose POL, Plastic Handwheel	1/4" Male Inverted Flare
MER404AR-"X"	18, 24, 36	#60 Orifice Hole Male Soft Nose POL, Brass Round Handwheel	1/4" Male Inverted Flare
MER406AR-"X"	12, 24, 36, 48, 60	Male Soft Nose POL, Brass Round Handwheel	1/4" MNPT
MER405-"X"	12, 15, 18, 20, 24, 30, 36, 48, 60	.9 GPM Excess Flow Male POL, 7/8" Nut	1/4" MNPT
MER414-"X"	10, 14, 120	1/4" MNPT	1/4" MNPT
MER422-"X"	6, 240	1/4" Female Flare Swivel	1/4" MNPT
MER434-"X"	36, 50	3/8" Female Flare Swivel	1/4" MNPT
MER429-"X"	72, 360	9/16"-18 Female Left Hand Swivel	1/4" MNPT
MER426-"X"	15, 20, 60	Female QCC, Type I Connection	1/4" MNPT
MER410-"X"	10, 12, 20, 24, 30, 36, 48, 60, 72, 120, 144, 180	3/8" MNPT	3/8" Female Flare Swivel
MER413-"X"	24, 36, 48, 60, 72, 96, 120, 144, 180	3/8" Female Flare Swivel	3/8" Female Flare Swivel
MER408-"X"	12, 36, 60, 72, 144, 288	9/16"-18 Female Left Hand Swivel	9/16"-18 Female Left Hand Swivel
MER407-"X"	24, 36, 48, 60, 72, 120, 144	Male Soft Nose POL, Plastic Handwheel	1"-20 Male Swivel
MER421-"X"	24, 48, 60, 72, 144	1"-20 Female Swivel	1"-20 Male Swivel

* Replace "X" with the desired hose length i.e. MER409-24



Hose Barbs

Part No.				Hose I.D.	Threads
Brass		Steel ¹			
Four Barb Low Pressure	Seven Barb High Pressure	Four Barb	Four Barb with 3/64" Orifice Hole		
ME4631	—	—	—	1/4"	1/8" FNPT
ME4632	ME5632	—	—	1/4"	1/4" FNPT
ME4633	ME5633	—	—	1/4"	3/8" FNPT
ME4652	—	—	—	3/8"	1/4" FNPT
ME4653	ME5653	—	—	3/8"	3/8" FNPT
ME4654	—	—	—	3/8"	1/2" FNPT
ME4231	ME5231	—	—	1/4"	1/8" MNPT
ME4232	ME5232	—	—	1/4"	1/4" MNPT
ME4233	ME5233	—	—	1/4"	3/8" MNPT
—	—	A6132	A6133	3/8"	1/8" MNPT
ME4252	—	A1132	A1133	3/8"	1/4" MNPT
ME4253	ME5253	—	—	3/8"	3/8" MNPT
ME4254	—	—	—	3/8"	1/2" MNPT
—	—	A6138	A6139	1/2"	1/8" MNPT
—	—	A1138	A1139	1/2"	1/4" MNPT
ME4273	—	—	—	1/2"	3/8" MNPT
ME4274	ME5274	—	—	1/2"	1/2" MNPT
ME4293	—	—	—	5/8"	3/8" MNPT
ME4835	ME5835	—	—	1/4"	3/8" Male Flare
ME4855	—	—	—	3/8"	3/8" Male Flare
ME4857	—	—	—	3/8"	1/2" Male Flare
—	ME5133	—	—	1/4"	1/4" Male Inverted Flare
ME4333	—	—	—	1/4"	1/4" Female Flare Swivel
ME4335 ²	ME5334 ^{5,6} ME5335	—	—	1/4"	3/8" Female Flare Swivel
ME4355 ³	ME5336 ⁶ ME5355	—	—	3/8"	3/8" Female Flare Swivel
ME4357	ME5357	—	—	3/8"	1/2" Female Flare Swivel
ME4377 ⁴	ME5377	—	—	1/2"	1/2" Female Flare Swivel

1—Rated for LP-Gas & NH₃ 4—ME4377-1 (barb only); ME4377-2 (nut only)
 2—ME4335-1 (barb only); ME4335-2 (nut only) 5—ME5334-1 (barb only)
 3—ME4355-1 (barb only); ME4335-2 (nut only) 6—Forged Nut



ME4652



ME5632



ME5233



ME4252



A1132



ME4835



ME5133



ME5335



Hose Ferrules & Hose Menders



ME7327

Part No.	I.D.	OAL
ME7323	.525"	1"
ME7324	.531"	1"
ME7325	.562"	1"
ME7326	.593"	1"
ME7327	.625"	1"

Part No.	I.D.	OAL
ME7329	.687"	1"
ME7330	.718"	1"
ME7331	.750"	1"
ME7332	.781"	1"
ME7333	.812"	1"



ME27C



ME27E

Part No.	Hose I.D.
ME27C	1/4" x 1/4"
ME27E	3/8" x 3/8"

Low Temperature Leak Detector

General purpose leak detector for all pressurized gases. Designed to detect joint leaks within 5 seconds of proper application at temperatures down to -40° F.

Part No.	Size	Description
ME-LD02	2 Ounces	Spray Bottle
ME-LD1	8 Ounces	Cap and Dauber
ME-LD16	16 Ounces	Cap and Brush
ME-LD2	1 Gallon	Container



ME-LD02



ME-LD16



ME-LD2

High Pressure Test Blocks

Designed to test high pressure lines downstream of the container valve for system leaks. The optional bleeder valve enables the line pressure to be adjusted to the desired test pressure.

Part No.	Inlet	Outlet	PSIG	Factory Installed Vent Valve
MEJ600	Male Hard Nose POL	Female POL	0-300	No
MEJ601	Male Hard Nose POL	Female POL	0-300	Yes
MEJ601-WOG*	Male Hard Nose POL	Female POL	—	Yes

* Without gauge



MEJ600



MEJ601

Low Pressure Test Kits & Adapters

These kits are designed to check for gas leaks by verifying the line pressure of an appliance. Each kit includes a case, gauge, and rubber hose with a bell on the end.

Low Pressure Test Kit Features

- Capacity 0 - 35" water column
- Adjustable gauge models can be reset to zero with provided screwdriver
- Three foot rubber hose with bell



ME60P-2



ME50P-2



ME50P-5



ME50-2



ME1332

Part No.				Adjustable Gauge	Manometer Adapter
Kit with Case	Gauge & Hose Only	Gauge & Hose Barb Connection	Gauge & 1/4" MNPT Connection		
ME60P-2	ME60P-5	—	ME60-2	Yes	ME1328 (3/8" OD) ME1331 (1/2" OD) ME1332 (5/8" OD)
ME50P-2	ME50P-5	ME50-2	ME50-2-01	No	

The serviceman's friend (METL051 & METL052) eliminates the hassle of carrying numerous bushing and fittings to each job site. It has three threads on one end with a hose barb and an 1/8" MNPT on the other end. A hose can easily be attached to either end and can be connected to a manometer or other flow meters to check line pressure on an appliance.



METL051

Part No.	Connection	Connection
METL051	5/16"-32 Male / 1/8" MNPT / 1/2" MNPT	Standard test hose fitting/1/8" MNPT
METL052	5/16"-32 Male / 1/8" MNPT / 1/4" MNPT	Standard test hose fitting/1/8" MNPT

Low Pressure Test Block

Designed to test low pressure lines for system leaks. The factory installed check valve allows the line to be pressurized and adjusted to the desired test pressure.

Part No.	Inlet	PSIG
MEJ610/15	3/4" FNPT	0-15
MEJ610/30	3/4" FNPT	0-30
MEJ610/60	3/4" FNPT	0-60
MEJ610/100	3/4" FNPT	0-100



MEJ610/30



Pressure Test Accessories

These accessories are easily adaptable to industry standard pressure test equipment and provide a very reliable, inexpensive, permanent way to test both high and low pressure lines in domestic tank installations.

Test Gauge Features

- Reliable method to test high and low pressure tap installations
- Provides an effective method to bleed vapor for pressure equalization and more accurate gauge readings
- Allows for an effective method to bleed vapor from the testing equipment prior to disconnect
- High quality liquid filled pressure gauge



MEJ603HP

Designed to provide an inexpensive way to permanently install a pressure tap upstream or downstream from the first stage regulator. The #54 orifice port provides controlled line pressure for more accurate readings and protects test equipment from pressure spikes while allowing easy installation of pressure test monitoring devices.

Part No.		Connection	Connection	Port Hole with #54 Orifice
With Plug	Without Plug			
ME295	ME295-1	Male Hard Nose POL	Female POL	1/8" FNPT
ME295SN	ME295SN-1	Male Soft Nose POL	Female POL	1/8" FNPT
ME296	ME296-1	1/4" MNPT	1/4" FNPT	1/8" FNPT
ME297	ME297-1	3/8" MNPT	3/8" FNPT	1/8" FNPT
ME298	ME298-1	1/2" MNPT	1/2" FNPT	1/8" FNPT
—	MEJ595	1/2" MNPT	1/2" FNPT	1/4" FNPT with no Orifice
ME299	ME299-1	3/4" MNPT	3/4" FNPT	1/8" FNPT

Part No.	Outlet	Inlet	PSIG	Factory Installed Vent Valve
MEJ602*	1/4" FNPT	1/4" MNPT	—	Yes
MEJ603LP	1/4" FNPT	1/4" MNPT	0-15	Yes
MEJ603HP	1/4" FNPT	1/4" MNPT	0-300	Yes

* Without gauge



ME295-1



ME296-1

#54 Orifice



MEJ595



MEJ604

This check valve allows the line to be pressurized and adjusted to the desired pressure through the same valve.

Note: To help eliminate valve failure, the valve cap should remain on the valve when line is not be pressurized or adjusted. Any dirt, debris, water or other contaminants can potentially jam the valve or compromise the sealing surface causing the valve to leak.

Part No.	Connection	Connection	Description
MEJ604	1/4" FNPT	1/8" MNPT	Extension

These accessories are intended for first stage regulators with pressure taps in either the upstream or downstream positions.



MER432 Series



MEJ608B-02

Part No.	Connection	Connection	Thread Sealant
MEJ607-02	1/4" MNPT	5/16"-32 Male	No
MEJ608-02	1/8" MNPT	5/16"-32 Male	No
MEJ608B-02	1/8" MNPT	5/16"-32 Male	Yes

Part No.	Connection	Connection	Approx. Length
1/4" Hose ID			
MER432-6	1/8" MNPT	1/4" FNPT	6"
MER432-12	1/8" MNPT	1/4" FNPT	12"



ME10BTK-1-01

Part No.	Connection	Connection
ME10BTK-1-01	1/8" FNPT	5/16"-32 Female

Flex-Vent™ Regulator Vent Kit

The MEC Flex-Vent™ provides a safe and easy solution to vent LP Gas regulators away from open sources of ignition or other potential fire hazards. Meets all requirements of the new flexible material allowance in the 2011 NFPA-58, section 5.8.3.1 (3).



ME960 Series

MEC Flex-Vent™ Features

- Durable, UV stable flexible PVC hose material suitable for use with LP Gas vapor
- 3/4" NPT swivel inlet for easy installation
- Standard 90° vent assembly with screen
- Mounting clamps and coated masonry screws supplied
- Crimped ends for maximum durability
- Available in 3, 4, 6 & 10 ft. lengths*



ME900-6

Part No.	Description	Accessories
ME960-36	MEC Flex-Vent Kit - Fixed Ends - 3 ft.	90° Regulator Vent Assembly ME900-6
ME960-48	MEC Flex-Vent Kit - Fixed Ends - 4 ft.	
ME960-72	MEC Flex-Vent Kit - Fixed Ends - 6 ft.	
ME960-120	MEC Flex-Vent Kit - Universal Outlet (not crimped) - 10 ft.	
ME960-120C	MEC Flex-Vent Kit - Universal Outlet (crimped) - 10 ft.	

* Custom lengths available upon request

LED 12V Light Strip

Universal LED Light Strip can be installed anywhere to provide extra lighting right where you need it.

LED 12V Light Strip

- Bright White LED
- Pre-Applied 3M Adhesive backing for easy installation
- Can be cut to any length

Part No.	Description
MEP104-95	LED Light Strip



Replacement Parts

	Part No.	Description
Acme Adapters	ME251-02	3-1/4" Acme Screen
	ME251-03	3-1/4" Acme Retaining Ring for Screen
Acme Gaskets	MEW4	1-1/4" Acme Flat Gasket for Motor Fuel
	MEW3	1-1/4" Acme Flat Gasket
	MEW2	1-3/4" Acme Flat Gasket
	MEW5	2-1/4" Acme Flat Gasket
	MEW6	3-1/4" Acme Flat Gasket
Back Check Valves	ME870-6-06	3/4" Back Check Valves O-ring
	ME870-10-06	1-1/4" Back Check Valves O-ring
	ME870-16-06	2" Back Check Valves O-ring
	ME870-24-06	3" Back Check Valves O-ring
Combination Valves	ME815K	Bonnet Assembly for ME830
Container Fill Valves	ME601-902	Replacement 1-3/4" F. Acme Cap w/ Lanyard - Plastic
	ME601-6SRK	Complete Seal Repair Kit For ME601-6 Fill Valve
	ME601-10SRK	Complete Seal Repair Kit For ME601-10 Fill Valve
	ME601-10-108	Replacement Nylon Body Gasket For ME601-10
	ME601-10-901	Replacement Molded Valve Poppet For ME601-10
ESV Emergency Shutoff Valves	ME980-903K	1-1/4" -3" ESV Cable Latch Assembly
	ME980-904K	1-1/4" -3" ESV Pneumatic Latch Assembly
	ME980-905	Universal Thermally Activated Remote Cable Release Mechanism
	ME980-905-25	Universal Thermally Activated Remote Cable Release Mechanism w/ 25' Cable
	ME980-905-50	Universal Thermally Activated Remote Cable Release Mechanism w/ 50' Cable
	ME980-906-25	Universal Remote Release Cable - 25'
	ME980-906-50	Universal Remote Release Cable - 50'
	ME980-907	Remote Thermally Activated Elbow 1/4" cc Inlet - For Pneumatic Latch Systems
	ME980-6K	3/4" - 1" ESV Complete Repair Kit
	ME980-6SRK	3/4" - 1" ESV Valve Seal Repair Kit
	ME980-10-901	1-1/4" Replacement (ESV) & Back Check Valve Clapper Assy.
	ME980-16-901	2" Replacement (ESV) & Back Check Valve Clapper Assy.
	ME980-24-901	3" Replacement (ESV) & Back Check Valve Clapper Assy.
	ME980-10K	1-1/4" (ESV) Complete Valve Repair Kit
	ME980-16K	2" (ESV) Complete Valve Repair Kit
	ME980-24K	3" (ESV) Complete Valve Repair Kit
	ME980-10SRK	1-1/4" (ESV) Seal Repair Kit
	ME980-16SRK	2" (ESV) Seal Repair Kit
	ME980-24SRK	3" (ESV) Seal Repair Kit
	Excelsior Internal Valves 1-1/4" Threaded	ME990-10-VRK
ME990-10-SRK		Excelsior 1-1/4" Internal Valve Seal Repair Kit
ME990-10-PRK		Excelsior 1-1/4" Internal Valve Stem Packing Repair Kit
ME990-10-PGA		Excelsior 1-1/4" Internal Valve Stem Packing Gland Assy.
ME990-10-106-35		Excelsior 1-1/4" Internal Valve Excess Flow Spring - 35 GPM (Blue)
ME990-10-106-55		Excelsior 1-1/4" Internal Valve Excess Flow Spring - 55 GPM (Green)
ME990-10-106-85		Excelsior 1-1/4" Internal Valve Excess Flow Spring - 85 GPM (Orange)
ME990-10-129		Excelsior 1-1/4" Internal Valve Manual Lever
MEP147-01		1-1/4" Plated Steel Cable Connector Ring For 1-1/4"-3" Internal Valves

Replacement Parts

	Part No.	Description
Excelerator Internal Valves 2" & 3" Threaded and Threaded Tee Body	ME990-140	Excelerator 2"-3" Manual Operating Lever - Standard
	ME990-160	Universal Internal Valve Fusible Link 212 Degrees
	ME990-16-VRK	Excelerator 2" Internal Valve Rebuild Kit
	ME990-16-SRK	Excelerator 2" Internal Valve Seal Repair Kit
	ME990-24-VRK	Excelerator 3", 3"DF, 3"DFM Internal Valve Rebuild Kit
	ME990-24-SRK	Excelerator 3", 3"DF, 3"DFM Internal Valve Seal Repair Kit
	ME990-PRK	Excelerator 2" & 3" Internal Valve Stem Packing Repair Kit
	ME990-PGA	Excelerator 2" & 3" Internal Valve Stem Packing Gland Assy.
	ME990-16-106-110	Excelerator 2" Internal Valve Excess Flow Spring - 110GPM (Yellow)
	ME990-16-106-160	Excelerator 2" Internal Valve Excess Flow Spring - 160GPM (Green)
	ME990-16-106-260	Excelerator 2" Internal Valve Excess Flow Spring - 260GPM (Blue)
	ME990-106-175	Excelerator 3" Internal Valve Excess Flow Spring - 175GPM (Purple)
	ME990-106-250	Excelerator 3" Internal Valve Excess Flow Spring - 250GPM (Black)
	ME990-106-300	Excelerator 3" Internal Valve Excess Flow Spring - 300GPM (Green)
	ME990-106-375	Excelerator 3" Internal Valve Excess Flow Spring - 375GPM (Yellow)
	ME990-106-400	Excelerator 3" Internal Valve Excess Flow Spring - 400GPM (Red)
	ME990-106-475	Excelerator 3" Internal Valve Excess Flow Spring - 475GPM (Silver)
	ME990-106-500	Excelerator 3" Internal Valve Excess Flow Spring - 500GPM (White)
	MEP147-01	Cable Connector Ring for 1-1/4"-3" Internal Valves
Excelerator Internal Valves 3" Flanged & Double Flanged Off-Set	ME990-3DF-121	Excelerator 3" Double Flange Self-Guiding Poppet Retaining Nut
	ME990-3DF-122	Excelerator 3" Double Flange Retaining Nut Roll Pin
	ME990-3DF-138	Excelerator 3" Double Flange Screen Mounting Post
	ME990-3DF-144	Excelerator 3" Double Flange Filter Screen Perforated - Stainless Steel
	ME990-3DF-145	Excelerator 3" Double Flange Filter Cap Perforated - Stainless Steel
	ME990-3DF-146	Excelerator 3" Double Flange Screen Mounting Post - Locknut
	ME990-3DF-148	Excelerator 3" Double Flange Stem Guide Bracket
	ME930-244	Excelerator 3" Double Flange Stem Guide Bracket Screw #10-32
	ME990-151	3" Internal Valve Tank Side Mounting Stud 3-1/2" OAL B7
	ME904SK-02	3" Internal Valve Mounting Stud Standard Hex Nut 3/4-10 B8
	ME990-3DF-153	Excelerator 3" Double Flange Internal Valve Inlet Flange Gasket
	ME904S-3F-027	Excelerator 3" Double Flange Outlet/3" Modified Inlet Flange Gasket
	ME990-3DFO-102	Offset Stand-Off 1/2-13UNC-2A x 5/16-24UNF-2A x 1.67" OAL - SS
	ME990-3DFO-103	Offset Gland Plug 1-3/8-12UNF-2A x 1-5/8" HX - SS
	Excelerator Internal Valves 4" Flanged	MEP990-4F
ME990-4F-VRK		Excelerator 4" Internal Valve Rebuild Kit
ME990-4F-SRK		Excelerator 4" Internal Valve Seal Repair Kit
ME990-4F-PRK		Excelerator 4" Internal Valve Stem Packing Repair Kit
ME990-4F-PGA		Excelerator 4" Internal Valve Stem Packing Gland Assy.
ME990-4F-146		Excelerator 4" Internal Valve Filter Screen Retain Bolt - 1/4-28
ME990-4F-153		Excelerator 4" Internal Valve Inlet Flange Gasket
ME990-4F-172		Excelerator 4" Internal Valve Outlet Flange Gasket
ME990-4F-106-375		Excelerator 4" Internal Valve Excess Flow Spring - 375GPM (Cyan)
ME990-4F-106-500		Excelerator 4" Internal Valve Excess Flow Spring - 500GPM (Black)
ME990-4F-106-650		Excelerator 4" Internal Valve Excess Flow Spring - 650GPM (Green)
ME990-4F-106-850		Excelerator 4" Internal Valve Excess Flow Spring - 850GPM (Yellow)
ME990-4F-106-1250		Excelerator 4" Internal Valve Excess Flow Spring - 1250GPM (Red)
ME990-4F-106-1500		Excelerator 4" Internal Valve Excess Flow Spring - 1500GPM (White)

Replacement Parts

	Part No.	Description
Excelerator Internal Valves 4" Flanged	ME990-4F-144	Excelerator 4" Internal Valve Filter Screen Perforated - Stainless Steel
	ME990-4F-145	Excelerator 4" Internal Valve Filter Cap Perforated - Stainless Steel
	ME990-4F-162	Excelerator 4" Internal Valve Filter Screen/Cap #5 MESH
	ME990-4F-151	4" Internal Valve Mounting Stud 6-3/4" OAL B7 Xylan Coated
	ME990-152	3" Modified & 4" Internal Valve Mounting Stud Heavy Hex Nut 3/4-10 B8
	ME990-3F-24-150	3 & 4" Internal Valve Mounting Sleeve/Bushing
Excelerator <i>High Flow</i> Railcar ESV	ME983-SRK	Excelerator High Flow Railcar ESV - Seal Repair Kit - Nitrile
	ME983-VRK	Excelerator High Flow Railcar ESV - Complete Valve Repair Kit - Nitrile
	ME983-119-150	Excelerator High Flow Railcar ESV - Replacement Excess Flow Spring 150 GPM
	ME983-119-250	Excelerator High Flow Railcar ESV - Replacement Excess Flow Spring 250 GPM
	ME983-119-500	Excelerator High Flow Railcar ESV - Replacement Excess Flow Spring 500 GPM
	ME983-121	Excelerator High Flow Railcar ESV - Replacement Quick Disconnect Nipple
External Pressure Relief Valves	MEV250-015	MEV250 Series Stainless Steel Weep Hole Deflector
	MEV250-013	Relief Valve Dust Cap with Lanyard
Fill Check Adapters	ME571-06	Replacement Plastic Spacer Ring For ME571
	ME571-2-03	Replacement Nose Gasket For ME571
<i>Flex-Vent</i> Regulator Vent Kit	ME900-6	90° Regulator Vent Assembly w/ Filter
	ME960-106	Hose Clamp
	ME960-107	Anchor Screw
Accu-Max Float Gauges	ME930-905	ME930 Series 4" DOT Dial—Glow/Black
	ME930C-905	ME930 Series 4" DOT Dial—Silver/Black
	ME940-905	ME940 Series 8" ASME Dial—Glow/Black
	ME940C-905	ME940 Series 8" ASME Dial—Silver/Black
Flow Indicating Check Valve	ME981-901	1-1/4" - 3" Replacement Swing Check Indicator Dial
Gas Box	ME952-07	ME951 and ME952 Series Dust Cap
Globe & Angle Valves	ME815K	1/2", 3/4" & 1" Angle & Globe Valve Complete Bonnet Assembly
	ME815-10BRK	1-1/4" & 1-1/2" Angle & Globe Valve Complete Bonnet Assembly
	ME815-10SRK	1-1/4" & 1-1/2" Angle & Globe Valve Replacement Seal Repair Kit
	ME815-10/16HRK	1-1/4", 1-1/2" & 2" Angle & Globe Valve Replacement Handle & Retaining Nut
	ME815-16BRK	2" Angle & Globe Valve Complete Bonnet Assembly
	ME815IBC-16BRK	2" Angle & Globe Valve with Integrated Back Check Complete Bonnet Assembly
	ME815P-16BRK	2" Angle & Globe Valve with Pilot Complete Bonnet Assembly
	ME815-16SRK	2" Angle & Globe Valve Replacement Seal Repair Kit
	ME815IBC-16SRK	2" Angle & Globe Valve with Integrated Back Check Replacement Seal Repair Kit
	ME815P-16SRK	2" Angle & Globe Valve with Pilot Replacement Seal Repair Kit
	ME815-24BRK	3" Angle & Globe Valve Replacement Bonnet Assembly
	ME815-24SRK	3" Angle & Globe Valve Replacement Seal Kit
	ME815-24HRK	3" Angle & Globe Valve Replacement Handle Kit
	ME825-3F-BRK	3" Flanged Globe Valve Complete Bonnet Repair Kit
	ME825-3F-SRK	3" Flanged Globe Valve Seal Repair Kit
	ME825-4F-BRK	4" Flanged Globe Valve Complete Bonnet Repair Kit
	ME825-4F-SRK	4" Flanged Globe Valve Seal Repair Kit
	ME980SK-24	3" & 4"-300LB ESV & Globe Valve Flange Stud Kit
	ME904S-3F-027	3"-300 LB Spiral Ring Flange Gasket-Carbon Steel
	ME904S-4F-027	4"-300 LB Spiral Ring Flange Gasket-Carbon Steel

Replacement Parts

	Part No.	Description
<i>High Flow</i> Bypass Valves	ME840-6K	3/4" & 1" High Flow Bypass Complete Repair Kit - Less Spring
	ME840-6SRK	3/4" & 1" High Flow Bypass Complete Seal Repair Kit
	ME840-8-108-60	3/4" & 1" High Flow Bypass Valve Replacement Spring 25-60 PSI
	ME840-8-108-150	3/4" & 1" High Flow Bypass Valve Replacement Spring 50-150 PSI
	ME840-8-108-225	3/4" & 1" High Flow Bypass Valve Replacement Spring 100-225 PSI
	ME870-24-06	3/4" & 1" High Flow Bypass Valve Replacement Bonnet O-Ring
	ME840K	1-1/4" - 2" High Flow Bypass Complete Repair Kit - Less Spring
	ME840SRK	1-1/4" - 2" High Flow Bypass Seal Repair Kit
	ME840-16-108-40	1-1/4" - 2" High Flow Bypass Valve Spring 20-40 PSI
	ME840-16-108-70	1-1/4" - 2" High Flow Bypass Valve Spring 41-70 PSI
	ME840-16-108-90	1-1/4" - 2" High Flow Bypass Valve Spring 71-90 PSI
	ME840-16-108-125	1-1/4" - 2" High Flow Bypass Valve Spring 91-125 PSI
	ME840-16-108-150	1-1/4" - 2" High Flow Bypass Valve Spring 126-150 PSI
	ME868-16-05	1-1/4" - 2" Universal 4 Bolt Flange O-Ring
	ME840-16-109	1-1/4" - 2" Universal Bonnet O-Ring
	ME840-16-110	1-1/4" - 2" Universal Spring Guide O-Ring
	ME840-16-104	1-1/4" - 2" Universal Valve Poppet - Stainless Steel
	ME840C-16-104	1-1/4" - 2" Classic Style Valve Poppet - Stainless Steel
	ME840-24K	3" High Flow Bypass Complete Repair Kit - Less Spring
	ME840-24SRK	3" High Flow Bypass Seal Repair Kit
ME840-24-105-100	3" High Flow Bypass Valve Spring 0-100 PSI	
ME840-24-105-200	3" High Flow Bypass Valve Spring 100-200 PSI	
Hose Clamps	ME3162-08-02K	1 Pair 1/2" Hose Clamps & Bolts
	ME3162-12-02K	1 Pair 3/4" Hose Clamps & Bolts
	ME3162-16-02K	1 Pair 1" Hose Clamps & Bolts
	ME3162-20-02K	1 Pair 1-1/4" Hose Clamps & Bolts
	ME3162-24-02K	1 Pair 1-1/2" Hose Clamps & Bolts
	ME3162-32-02K	1 Pair 2" Hose Clamps & Bolts
Hose End Holster	MEP801-03	MEP801 Series Black Urethane Holster Sleeve
	MEP801-04	MEP801 Series Black Urethane Holster Strap
Hose End Swivel	ME850SS-K	Seal Repair Kit
Hose End Valves	ME800-HRK	ME800 and ME800EXT Series Handle Repair Kit
	ME800-LSRK	ME800 and ME800EXT Series Lower Seal Repair Kit
	ME800-SARK	ME800 and ME800EXT Series Stem Assembly Repair Kit
	ME800-USRK	ME800 and ME800EXT Series Upper Seal Repair Kit
Industrial Regulator MEGR-164 Series	MEGR-164-03	Replacement Diaphragm for MEGR-164 Series
Industrial Regulator MEGR-198H Series	MEGR-198H-03	Replacement Diaphragm for MEGR-198H Series
Industrial Regulator MEGR-1133 Series	MEGR-1133H-01/05	2-5PSI Spring For MEGR-1133H Series

Replacement Parts

	Part No.	Description
Industrial Regulator MEGR-CS1200 Series	MEGR-CS1200-02/25	1/4" Orifice For MEGR-CS1200 Series
	MEGR-CS1200-02/312	5/16" Orifice For MEGR-CS1200 Series
	MEGR-CS1200-02/38	3/8" Orifice For MEGR-CS1200 Series
	MEGR-CS1200-02/50	1/2" Orifice For MEGR-CS1200 Series
	MEGR-CS1200-01/6.5	3.5-6.5"WC Spring For MEGR-CS1200 Series - Red
	MEGR-CS1200-01/14	6-14"WC Spring For MEGR-CS1200 Series - Green
	MEGR-CS1200-01/33	12-33"WC Spring For MEGR-CS1200 Series - Orange
	MEGR-CS1200-03	Replacement Diaphragm For MEGR-CS1200 Series
Industrial Regulator MEGR-S1202 Series	MEGR-S1202-02/50	1/2" Orifice For MEGR-S1202 Series
	MEGR-S1202-02/75	3/4" Orifice For MEGR-S1202 Series
	MEGR-S1202-02/100	1" Orifice For MEGR-S1202 Series
	MEGR-S1202-02/1187	1-3/16" Orifice For MEGR-S1202 Series
	MEGR-S1202-01/9	5-9"WC Spring For MEGR-S1202 Series - Black
	MEGR-S1202-01/18	8.5-18"WC Spring For MEGR-S1202 Series - White
	MEGR-S1202-01/30	14-30"WC Spring For MEGR-S1202 Series - Green
	MEGR-S1202-01/2	1-2 PSI Spring For MEGR-S1202 Series - Blue
	MEGR-S1202-01/3.25	1.5-3.25PSI Spring For MEGR-S1202 Series - Orange
	MEGR-S1202-01/5	2-5PSI Spring For MEGR-S1202 Series - Yellow
	MEGR-S1202-03	Replacement Diaphragm For MEGR-S1202 Series
Industrial Regulator MEGR-1289 Series	MEGR-1289-8-01/4.5	1-4.5 PSI Spring For MEGR-1289 1" Series - Pink
	MEGR-1289-8-01/15	4-15 PSI Spring For MEGR-1289 1" Series - Red
	MEGR-1289-8-01/20	10-20 PSI Spring For MEGR-1289 1" Series - Silver
	MEGR-1289-8-01/50	15-50 PSI Spring For MEGR-1289 1" Series - Green
	MEGR-1289-8-03	Replacement Diaphragm For MEGR-1289 1" Series
	MEGR-1289-16-01/18	7-18"WC Spring For MEGR-1289 2" Series - Blue
	MEGR-1289-16-01/2.25	.5-2.25PSI Spring For MEGR-1289 2" Series - Grey
	MEGR-1289-16-01/7	1.75-7 PSI Spring For MEGR-1289 2" Series - Green
	MEGR-1289-16-01/10	4-10 PSI Spring For MEGR-1289 2" Series - Red
	MEGR-1289-16-03	Replacement Diaphragm For MEGR-1289 2" Series
Industrial Regulator MEGR-1627 Series	MEGR-1627-01/20	5-20 PSI Spring For MEGR-1627 Series - Yellow
	MEGR-1627-01/40	15-40 PSI Spring For MEGR-1627 Series - Green
	MEGR-1627-01/95	10-95 PSI Spring For MEGR-1627Series - Blue
	MEGR-1627-02/25	1/4" Aluminum Orifice For MEGR-1627 Series
	MEGR-1627-02/38	3/8" Aluminum Orifice For MEGR-1627 Series
	MEGR-1627-02/50	1/2" Alum Orifice For MEGR-1627 Series
	MEGR-1627-04	Vent Assembly For MEGR-1627 Series
	MEGR-1627-05	Adjusting Screw Cover - Plastic For MEGR-1627 Series
	MEGR-1627-03	Replacement Diaphragm For MEGR-1627 Series
	MEGR-1627-03R	Replacement Diaphragm For MEGR-1627R Series
Industrial Regulator MEGR-1630 Series	MEGR-1630-01/10	3-10 PSI Spring For MEGR-1630 Series
	MEGR-1630-01/20	8-20 PSI Spring For MEGR-1630 Series
	MEGR-1630-01/30	17-30 PSI Spring For MEGR-1630 Series
	MEGR-1630-02/25	1/4" Orifice For MEGR-1630 Series
	MEGR-1630-02/38	3/8" Orifice For MEGR-1630 Series
	MEGR-1630-02/50	1/2" Orifice For MEGR-1630 Series
	MEGR-1630-04	Vent Assembly For MEGR-1630 Series
	MEGR-1630-03	Replacement Diaphragm For MEGR-1630 Series

Replacement Parts

	Part No.	Description
Internal Valve Actuators	ME205-013	212° F. Thermal Safety Plug for ME205, ME205R, ME225, ME226, ME227, ME228, ME552, ME710
	ME206-09	212° F. Thermal Safety Plug for ME206, ME207, ME207SF, ME208SF
Keys	ME530-03	ME530, ME531, ME532 and ME533 Series Key
	ME578-02	ME578 and ME600 Series Key
Liquid Withdrawal Adapters & Tank Valves	ME461	1-5/8" UNS Female Thread Replacement Cap and Gasket for ME460 & ME462
	ME461S	1-5/8" UNS Female Thread Replacement Cap and Gasket for ME462S
	ME461SS	1-5/8" UNS Female Thread Replacement Cap and Gasket for ME462SS
	ME458-03	ME458, ME460 and ME462 Series Nylon Gasket
	ME458-04	ME458 Series Nitrile O-ring
Low Pressure Test Kits	ME50-H	ME50P-2 and ME60P-2 Hose and Bell Assembly
	ME60P-2-01	ME60P-2 Screw Driver to Adjust Gauge
Manifold (Relief Valves)	ME904S-3F-027	Replacement Excelerator 3" Double Flange Outlet/3" Modified Inlet Flange Gasket
	ME904S-4F-027	Replacement 4" Modified Flange Flexatalic Gasket For ME904S-4F
	ME904SK	Quad-Port, 3/4-10UNC Mounting Stud Kit W/Nuts - 8Studs
	ME904SK-02	Replacement 3" Internal Valve Mounting Stud Standard Hex Nut 3/4-10 B8
Moto-Seal	ME795-3-02	Replacement Tip Seal
Multipurpose Withdrawal Valves	ME670-BRK	Replacement Bonnet Assembly for ME670, ME671, ME672 & ME673 Series Valves
	ME670-SRK	Replacement Seal Repair Kit for ME670, ME671, ME672 & ME673 Series Valves
	ME670-USRK	Replacement Upper Stem Seal Repair Kit for ME670, ME671, ME672 & ME673 Series Valves
	ME670-HRK	Replacement Handle Repair Kit for ME670, ME671, ME672 & ME673 Series Valves
	ME671IBC-BRK	Replacement Bonnet Assembly for ME671IBC Series Valves
	ME671IBC-SRK	Replacement Seal Repair Kit for ME671IBC Series Valves
	ME670-107	Replacement Data Plate for ME670DEX
	ME670-108	Replacement Data Plate for ME670DBC
O-rings	588-110-01	POL O-ring
	ME220M-02	Motor Fuel Service Valve ME220M O-ring
POL Adapters	ME1002A	Male Hard Nose POL x 1/4" MNPT—Tailpiece Only
	ME1002B	7/8" POL Nut
	ME1002BLH	1-1/8" POL Nut
	ME1600AH	POL Hex Brass Handwheel
	ME1600AR	POL Round Brass Handwheel
	ME1630-02	Plastic Handwheel for 7/8" POL Nut
	ME1630-03	Plastic Handwheel Spring
POL Filler Couplings	ME390WR-1	6" Soft Nose Male Soft Nose POL with O-ring x 1/4" MNPT Stem—Brass
	ME390SWR-1	6" Soft Nose Male Soft Nose POL with O-ring x 1/4" MNPT Stem—Stainless Steel
	ME390-2H	.880 Left Handed Male Thread Extension with Forged Handle
Quick-Acting Toggle Valves	ME791K	Non-Locking Series Bonnet Repair Kit
	ME792K	Locking Series Bonnet Repair Kit
Service Valves	ME9101BRK	MEC Universal Bonnet Replacement Assembly w/o Handwheel
	ME9101C1BRK	MEC 100LB. Service Valve Bonnet Assy. w/ Handwheel
	ME9101P5BRK	MEC Engine Fuel Service Valve Bonnet Assy. w/ Handwheel
	ME9101C1-102	Universal Replacement POL Service Valve Handwheel
	ME9101P5-105	Universal Replacement Motor Fuel Service Valve Handwheel
	ME9101P5-109	Replacement Handwheel Screw #10-32 - Stainless Steel
	ME9101P5-113	Replacement Engine Fuel Service Valve Name Plate
	ME9101P5-114	Universal Replacement Bonnet Seal - Nylon

Replacement Parts

	Part No.	Description
Sight Flow Swing Check Valves	ME875S-16-05	ME875S-16 Glass
	ME875S-16-06	ME875S-16 Glass Gasket
	ME875S-16-07	ME875S-16 Nitrile O-ring Seal
	ME875S-24-05	ME875S-24 Glass
	ME875S-24-06	ME875S-24 Glass Gasket
	ME875S-24-07	ME875S-24 Nitrile O-ring Seal
Transfer Angle Valves	ME815K	ME449S and ME449EXS Series Bonnet Assembly
TURBO-FLO LE Shutoff Valve	ME807CRK	ME807-16 Coupling Repair Kit
	ME807SCRK	ME807S-16 Coupling Repair Kit
	ME807VRK	ME807-16 Valve Repair Kit
TURBO-FLO LE Transfer Valve	ME185	3-1/4" Acme Dust Plug with Lanyard
	ME806CRK	ME806-16 Coupling Repair Kit
	ME806VRK	ME806-16 Valve Repair Kit
Type I Filler Couplings	ME515-3	7" Male Hard Nose POL x 1/4" MNPT Stem—Brass
	ME516-1	6" Male Hard Nose POL x 1/4" MNPT Stem—Brass
	ME516S-01	6" Male Hard Nose POL x 1/4" MNPT Stem—Stainless Steel
	ME516-2H	1-5/16" F. Acme Extension with Forged Handle
Wheel Chock Bracket	ME200B-103	Replacement Rubber Bumper Pad
	ME200EXT	Wheel Chock Block 6" Standoff Extension Kit
Y-Strainers	ME650-03/20	1/2" & 3/4" Y-Strainers 20 Mesh Screen
	ME650-03	1/2" & 3/4" Y-Strainers 40 Mesh Screen
	ME650-03/80	1/2" & 3/4" Y-Strainers 80 Mesh Screen
	ME652-03/20	1" Y-Strainer 20 Mesh Screen
	ME652-03	1" Y-Strainer 40 Mesh Screen
	ME652-03/80	1" Y-Strainer 80 Mesh Screen
	ME653-02/20	1-1/4" Y-Strainer 20 Mesh Screen
	ME653-02	1-1/4" Y-Strainer 40 Mesh Screen
	ME653-02/80	1-1/4" Y-Strainer 80 Mesh Screen
	ME654-03	1-1/2" Y-Strainer 40 Mesh Screen
	ME655-03/20	2" Y-Strainer 20 Mesh Screen
	ME655-03	2" Y-Strainer 40 Mesh Screen
	ME655-03/80	2" Y-Strainer 80 Mesh Screen
	ME656-03	3" Y-Strainer 40 Mesh Screen
	ME656-03/80	3" Y-Strainer 80 Mesh Screen
	ME656S-3F-109	Replacement 3" Filter Flange Gasket
	ME656S-3F-110	Replacement 3" Filter Flange O-Ring
	ME656S-3F-901	Replacement 3" Flange Y-Strainer Filter
	ME656-4F-108	Replacement 4" Filter Flange Gasket
	ME656-4F-110	Replacement 4" Filter Flange O-Ring
	ME656S-4F-901	Replacement 4" Flange Y-Strainer Filter
	ME980SK-24	3" & 4"-300LB Flange Stud & Nut Kit
	ME904S-3F-027	3"-300 LB Flange Spiral Wound Gasket
	ME904S-4F-027	4"-300 LB Flange Spiral Wound Gasket

Index

Acme Adapters & Reducers.....	86-87	Internal Valves & Accessories	54-63
Acme Caps, Flanges & Plugs.....	88-89	Leak Detector.....	119
Acme Spanner Wrenches.....	89	LED Light Strip	122
Actuators & Accessories.....	61-62, 64	Liquid Transfer Valves & Adapters.....	49-51, 53
Back Check Valves.....	28, 42, 45-46, 65, 67, 82	Locking Handwheel Kit.....	32
Breakaway Couplings & Accessories.....	81, 83	Low Emission Products	26-28, 37, 79-80, 83-84, 96
Bulkheads	84, 95	Low Pressure Test Blocks, Kits & Accessories	120-121
Bypass Valves.....	34-35	Manifolds (Relief Valves).....	72
Camping Elbows, Fittings & Tees	107-109	Methanol Injector.....	101
Camping Kits & Adapters	110-111	Multipurpose Valves	52-53
Carburetion Equipment	84	Needle Valves.....	93
CGA 555 Fittings.....	114	Pigtails (Copper).....	115-116
Combination Valves	51-53	Pipeaway Adapters.....	78, 81
Container Fill Valves	52-53, 82, 94-95	Pipe Thread Adapters.....	36, 39, 47, 51, 73, 81, 86-87, 92, 100, 104, 106, 109, 111, 114, 118, 121
Container Service Valves	52-53, 94-95	POL Filler Couplings	97, 102
Cylinder Collars	100	POL Fittings.....	97, 100, 102-108, 110-111, 114, 119, 121
Cylinder Valve Wrenches (OPD/QCC & POL).....	74, 95, 102	POL Thread Clean Out Tool	105
Dielectric Pigtails	115	Pressure Gauges & Accessories	91-93, 119-121
Dielectric Unions.....	111	Pressure Test Kits, Blocks & Accessories.....	119-121
Dispensing Valves (Quick Acting).....	37, 41, 101	Quick Connect Filler Coupling	97
Double Back Check Valves.....	46	Railcar ESV	68
Double Check Filler Valves.....	94	Regulators	4-24
Engine Fuel Valves & Accessories.....	84, 96	Relief Valves & Accessories (Hydrostatic).....	78
Emergency Shutoff Valves & Accessories.....	64-66, 68	Relief Valves & Accessories (Pressure).....	69-77
Excess Flow Adapters .98, 100, 103-104, 106-108, 110-111, 114, 117		Safe-T-Locks.....	105
Excess Flow Valves (Container)	44, 52-53	Seal Gasket Kit	92
Filler Couplings.....	26, 85, 96-97, 102	Service Valves	52-53, 94-95
Fill Check Adapters (Hose End)	42	Sight Flow Valves	82
Ferrules & Menders (Hose).....	119	Single Check Remote Fill Valve	95
Fixed Maximum Liquid Level Gauges.....	51, 79-80	Smart Interlock Technologies & Accessories	28, 39-40
Flange Unions.....	36	Strainers	80, 87
Flare Fittings.....	112-114, 118, 120	Swivel Connectors (Hose End).....	37, 39
Flex-Vent Regulator Vent Kit.....	122	Tank Filler Valves	52-53, 82, 94-96
Float Gauges & Accessories	47-48	Tee Check & Block Manifolds.....	106, 119, 120-121
Flow Indicating Check Valve.....	65, 67	Thermometers (Container).....	91
Four Bolt Flange Union	36	Toggle Valves (Quick Acting).....	37, 41, 101
Gas Box (Convenience Outlet).....	99	Turbo-Flo LE Transfer System & Accessories	27-28
Globe & Angle Valves.....	29-33	Turbo-Flo LE Shutoff Valve	26
Grounding Stud	39	Type I (QCC) Filler Couplings & Caps	97-98
High Pressure Gas Connections.....	114	Type I (QCC) Connectors	98
High Pressure Test Blocks & Accessories	119, 121	Underground Tank Cluster Removal Tool	74
Hogtails (Copper).....	115-116	Utility Bracket.....	90
Hose Barbs.....	98, 103, 118-119	Vapor Couplings.....	84-85
Hoses (Thermoplastic)	99, 110, 116-117	Vent Valves.....	79-80
Hose End Delivery Valves & Accessories	37-39	Wheel Chocks & Accessories	90
Hose End Valve Holster	38, 40	Withdrawal Valves	49-50, 52-53
Hose End Swivel Connectors.....	37-39	Y-Strainers.....	80
Hose Clamp Couplings	81		
Hose Reel Control Switch Covers	93		
		Replacement Parts.....	123-129

Warranty Information

Warning

Marshall Excelsior's products are mechanical devices made of materials such as rubber and metal, and are subject to wear, the effects of contaminants, corrosion, and aging, and these devices will eventually become inoperative. **Regular inspection and maintenance is essential.** Marshall Excelsior's products have a long record of quality and service, and therefore LP-Gas dealers may forget hazards that can arise from using aging devices that have outlived their safe service life. The safe service life of these products will be affected by the environment and the conditions of their use. The LP-Gas dealer knows better than anyone what this environment and the conditions of use are.

There are developing trends in state legislation and proposed national legislation making the owner of products responsible for replacing products before they outlive their safe service life. LP-Gas dealers should be aware of such legislation as it affects them.

All Marshall Excelsior products must be installed, inspected and maintained by a trained and experienced professional adhering to all installation instructions, product and safety warnings, local, state, and federal regulations, codes and standards and any other standards set by, but not limited to, NFPA, DOT or ANSI.

LP-Gas is a highly explosive and flammable gas that should never be vented near a possible ignition source.

Limited Warranty

THIS WARRANTY for Marshall Excelsior manufactured products is provided by Marshall Excelsior, Inc., 1506 George Brown Drive, Marshall, MI 49068. Marshall Excelsior, unless otherwise specified in writing, warrants to the original buyer that for a period of five (5) years from the date of manufacture its products and repair kits will be free from defects in material and workmanship under normal service and use. This warranty covers manufacturing defects only, and does not cover defects and product non-compliance due to, misuse, alteration, neglect, accident, fire, or other external causes, alterations, or repairs. This limited warranty also does not cover normal wear and tear. During this warranty period, if a defect arises in the product, and you follow the instructions for returning the product, Marshall Excelsior will, at its option, to the extent permitted by law, either (i) repair the product using either new or refurbished parts, (ii) replace the product with a new or refurbished product that is equivalent to the product that is to be replaced, or (iii) refund to you all or part of the purchase price of the product. This limited warranty applies to the extent permitted by law, to any repair, replacement part or replacement device for the remainder of the original warranty period or for ninety (90) days whichever period is longer. All replaced parts and products for which a refund is given shall become the property of Marshall Excelsior. This is the only warranty or representation made by Marshall Excelsior, and the sole basis for liability respecting quality, performance, defects, repair, delivery, and replacement of products and repair kits. The foregoing shall constitute Marshall Excelsior's sole liability.

Marshall Excelsior does not warrant any product or part that has been altered, accidentally damaged, disassembled, modified, misused, neglected, not properly maintained or installed, or not kept in continuous

service after installation. Marshall Excelsior does not warrant cosmetic issues including but not limited to dents, scratches, product discoloration, color fading or any other imperfection that does not affect the functionality of the product. Marshall Excelsior does not warrant any product or part not installed according to Marshall Excelsior's installation instructions or installed in violation of any regulation or warning by state, local, or federal regulators, or in violation of any standard or code set by, but not limited to, NFPA, DOT or ANSI requirements. The foregoing shall constitute Marshall Excelsior's sole liability to distributors, vendees and end users.

Limitations

TO THE EXTENT PERMITTED BY LAW, THE WARRANTY AND REMEDIES SET FORTH ABOVE ARE EXCLUSIVE AND IN LIEU OF ALL OTHER WARRANTIES AND REMEDIES, AND MARSHALL EXCELSIOR SPECIFICALLY DISCLAIMS ALL STATUTORY OR IMPLIED WARRANTIES, INCLUDING, BUT NOT LIMITED TO, WARRANTIES OF MERCHANTABILITY, FITNESS FOR A PARTICULAR PURPOSE AND AGAINST HIDDEN OR LATENT DEFECTS. IF MARSHALL EXCELSIOR CANNOT LAWFULLY DISCLAIM STATUTORY OR IMPLIED WARRANTIES, THEN TO THE EXTENT PERMITTED BY LAW, ALL SUCH WARRANTIES SHALL BE LIMITED IN DURATION TO THE DURATION OF THIS EXPRESS LIMITED WARRANTY AND TO REPAIR OR REPLACEMENT AND SERVICE.

MARSHALL EXCELSIOR IS NOT RESPONSIBLE FOR DIRECT, SPECIAL, INCIDENTAL OR CONSEQUENTIAL DAMAGES RESULTING FROM ANY BREACH OF WARRANTY OR UNDER ANY OTHER LEGAL THEORY.

MARSHALL EXCELSIOR'S LIABILITY (EXCEPT AS TO TITLE) ARISING OUT OF THE SALE, USE OR OPERATION OF PRODUCTS OR REPAIR KITS, WHETHER ON CLAIMS FOR BREACH OF WARRANTY, CONTRACT, NEGLIGENCE OR OTHERWISE (INCLUDING CLAIMS OF CONSEQUENTIAL OR INCIDENTAL DAMAGES) SHALL NOT IN ANY EVENT EXCEED THE COST OF FURNISHING OR REPLACEMENT OF THE DEFECTIVE PRODUCT OR REPAIR KIT.

Warranty Claims and Notice

Warranty claims shall be made in writing to Marshall Excelsior's Home Office at 1506 George Brown Drive, Marshall, Michigan 49068 by the distributor, vendee or end user within twenty (20) days of discovery of the defect and the product must be postmarked and shipped F.O.B. origin to Marshall Excelsior's Home Office within thirty (30) days of the discovery of the defect. Marshall Excelsior will not accept any products or repair kits that does not have a Return Material Authorization (RMA) number from the Home Office in Marshall, Michigan. After Marshall Excelsior has inspected the product and deemed the product to be defective, at its discretion, Marshall Excelsior will repair, replace or refund the purchase price of the defective product or repair kit. If the buyer does not comply with the above stated requirements the buyer will waive unconditionally and absolutely any and all claims arising out of the alleged defect.



Marshall Excelsior Company
1506 George Brown Drive
Marshall, MI 49068
Phone: 269.789.6700 Fax: 269.781.8340
www.marshallexcelsior.com
email: sales@marshallexcelsior.com